

Mariak

IMAGE
PRINTING NOW
AVAILABLE!

Roller Shade Section

Effective December 1, 2014

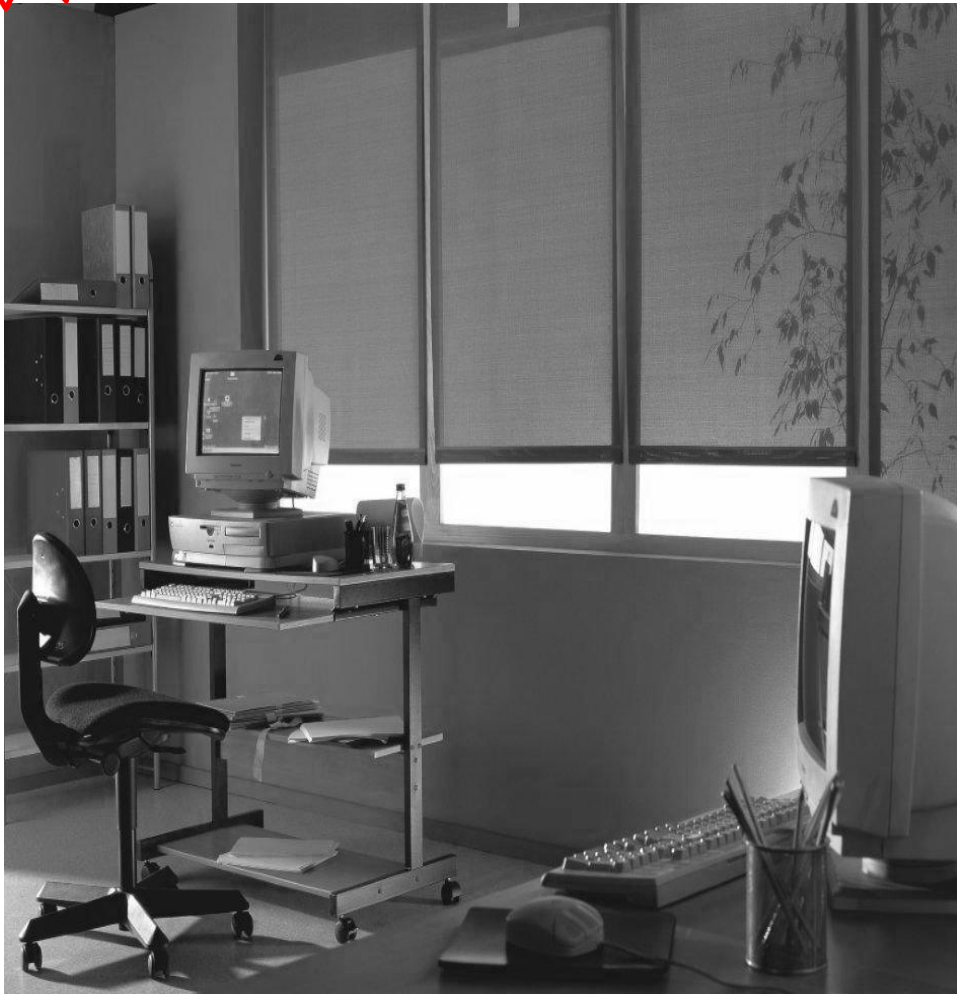

Save a life: "Install Safety Devices!"

Mariak

Roller Shade Measuring & Ordering Instructions

Selecting the Type of Mounting:

Determine whether the blind is going to be installed inside the window frame or outside the window frame.

Inside Mount (IB):

Measuring the Width and the Length for Inside Mount:

For the width, measure across the top, middle, and bottom of the window opening. Using the narrowest dimension, measure to the nearest 1/8". By using the narrowest measurement the shade will operate correctly.

For the length, measure the up and down dimension on the left, center, and right side. Use the longest length measurement, measuring to the nearest 1/8".

The factory will make any appropriate deductions. Do not make any width deductions.

Outside Mount (OB):

Outside mount installations are mounted on the wall or on the window molding. It is best to overlap the window opening at least 3/4" on each side when measuring for roller shades.

Measuring the Width and the Length for Outside Mount:

Measure the area that the shade is to cover. For roller shades it is recommended to overlap the window opening by at least 3/4" on each side for a total of 1 1/2". To allow for enough space for the mounting brackets and to cover the bottom of the window, the suggested overlap for a roller shade depends on the size of the shade and the valance option if required. If the window opening has a sill, measure from where the top of the shade will be located to the top of the window sill.

Note: When outside mount blinds are specified, no factory deductions are taken from the bracket to bracket measurement. There will be a fabric deduction as outlined on page 2.

Confirming Measurements:

The most common error in ordering blinds is reversing the width and the length measurements. Always confirm that the width is the measurement that goes across from left to right and that the length is the measurement that goes from top to bottom.

Clutch & Bracket Selection:

To determine the clutch and bracket size used by the factory for a specific shade, refer to the **Manual Clutch Fabrication Chart** at the end of the roller shade section of the suggested retail price book.

Bracket Dimensions:

Clutch & Bracket Used	Ceiling Mount Installation		Wall Mount Installation	
	Projection	Height	Projection	Height
1 1/4" M8 Clutch Bracket	1 7/8"	2 3/8"	2 3/8"	1 7/8"
1 1/2" M16 Clutch Bracket	2 7/8"	2 5/8"	2 5/8"	2 7/8"
1 3/4" M24 Clutch Bracket	3 1/4"	3"	3"	3 1/4"
3" Fascia M-Series Bracket	3"	3"	3"	3"
4" Fascia M-Series Bracket	4"	4"	4"	4"
Standard Motor Bracket	2 1/2"	2 7/8"	2 7/8"	2 1/2"
Platinum Clutch Bracket	3"	3 3/4"	3 1/4"	3 3/4"

Estimated Shade Roll-Up Diameters:

Refer to the chart below to calculate the approximate roll-up diameter for the given shade drops.

Shade Drop	Clutch Shade with 1 1/2" Tube	Clutch Shade with 1 3/4" Tube	Shade Drop	Motorized Shade with 2 1/2" Tube	Motorized Shade with 3" Tube
60"	±2.250"	±2.500"	60"	±3.125"	±4.000"
72"	±2.375"	±2.625"	96"	±3.250"	±4.125"
84"	±2.500"	±2.750"	120"	±3.500"	±4.250"
96"	±2.625"	±2.875"	144"	±3.625"	±4.375"
120"	±2.750"	±3.000"	168"	±3.750"	±4.500"
132"	±2.875"	±3.125"	192"	±3.875"	±4.625"
144"	±3.000"	±3.250"	216"	±4.000"	±4.750"
156"	±3.250"	±3.500"	240"	±4.250"	±5.000"

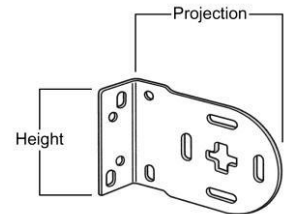
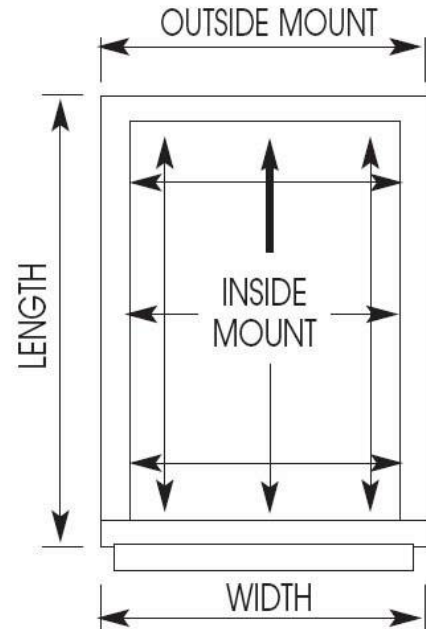
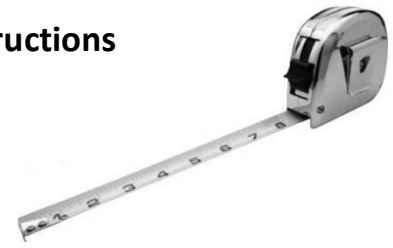

Bracket Shown as used in Wall Mount Installation

Mariak

Critical Information:

Shade Cloth Deductions & Light Gap: (All Measurements provided should be Bracket to Bracket!)

It is extremely important to note when measuring for roller shades that the actual fabric width of the shade will be less than the window measurement provided. To allow for the space that shade brackets, clutch or motor, and idler end take up, the factory must make a deduction so that the finished measurement or *bracket to bracket measurement* of the shade fits into the width dimension provided by the customer. Please note the below deductions taken by the factory on all shades.

Inside Mount Deduction: An additional 1/4" deduction will be taken for shades with fascia ordered as an inside mount

	Deductions	Explanation
M-Series Clutch	1 1/4"	The fabric width measurement will be 1 1/4" less than the ordered width.
Spring Loaded Shades	1 1/4"	The Fabric width measurement will be 1 1/4" less than the ordered width.
Platinum Series Clutch	1 3/8"	The fabric width measurement will be 1 3/8" less than the ordered width
Battery (LT30) or Low Voltage Motor (ST30)	1 1/4"	The fabric width measurement will be 1 1/4" less than the ordered width.
AC Hardwire Plug-In Motor (LT50 & ST50)	1 7/8"	The fabric width measurement will be 1 7/8" less than the ordered width.

Please Note: When shades with a Fascia are ordered inside mount, an addition 1/4" deduction will be taken for the fabric width.

Please Note: When shades with a Pocket "L" Fascia are ordered inside mount, an addition 3/8" deduction will be taken for the fabric width.

Shade Measurements: (Critical Note!)

Specify bracket to bracket width measurements for all roller shade orders. Do not provide fabric width measurements. If a specific shade cloth width is required, please refer to the list of shade cloth deductions above and add the required amount to the fabric width.

Fabric Telescoping & Tracking:

Roller shades that exceed a 3-to-1 length to width ratio where the shade is more that 3 times longer than it is wide, may have problems tracking or rolling up straight. This tracking problem, commonly referred to as *telescoping* is an inherent characteristic of roller shade fabrics and should be explained to the end user.

Railroading & Fabric Seams:

In order to make a shade that is wider than the width of the roll, the fabric will be *railroaded* or turned sideways and cut to the width of the shade. In cases where the shade is wider and longer than the width of the fabric roll, a second piece of fabric will be cut and welded or *spliced* to the first fabric piece. This weld, which secures the two pieces of fabric together, creates a visible seam. When a *splice* is required, the factory will place the seam as high on the shade as possible. If a custom *splice* location is desired, please specify the seam location *from the bottom of the shade up*. Please allow $\pm 1/2"$ tolerance when custom seam locations are requested.

Roll Direction: Regular Roll or Reverse Roll?

Regular Roll:

Regular roll shades indicate when the shade fabric rolls off of the back of the roller tube. The shade cloth will be closest to the window with this option.

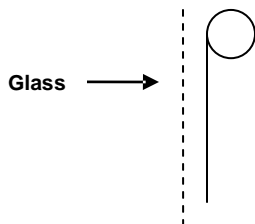

Regular roll shades are industry standard and yield the highest levels of energy conservation because of the shade's close proximity to the glass.

Reverse Roll:

Reverse roll shades indicate when the shade fabric rolls off of the front of the roller tube. The shade cloth will be furthest away from the window with this option.

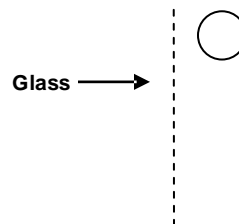

Reverse roll shades are most commonly used for the following applications:

- To avoid a window obstruction (door handle, etc.)
- To reduce light gap for corner or bay windows
- Fascia is not available with Reverse Roll

The follow surcharges will apply for purchases of individual slat, broken-boxes, pieces or cut-down products that are not purchased as a fully assembled blind or shade:

- \$ 10.00 NET – Components, Valance or Fascia Broken-Box charge All Products
- \$ 20.00 NET – Cut-Charge for All Products (i.e. Fabric, Slat, Valance, Fascia, etc.)

Mariak

Manual Roller Shades

Standard M-Series Clutch Roller Shade Exploded Diagram

In compliance with the latest manufacturing safety guidelines Mariak Industries Inc. includes with each fully-assembled product warning tags, warning labels, safety devices and cord cleats. Installers of the finished product must adhere to the safety guidelines as established by the installation instructions and by using all devices provided by the manufacturer. It is the responsibility of the installer, as well as the end consumer, to see that all safety devices are properly installed according to the manufacturers installation instructions included with each device and remain so throughout the life of the product. Mariak Industries, Inc. is not liable for injuries or fatal occurrences related to improper installation or maintenance of required safety devices.

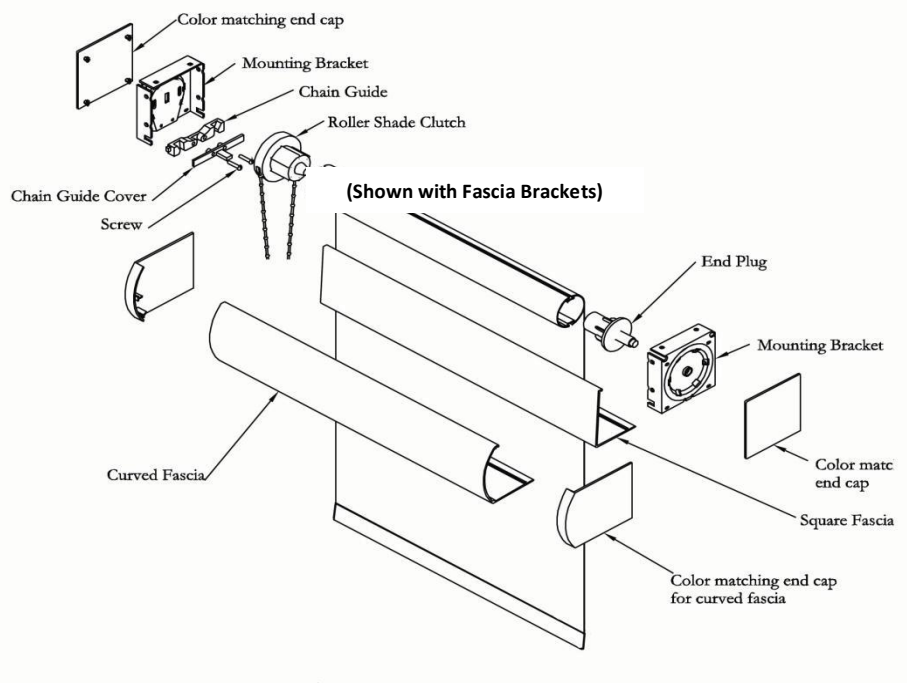

Standard M-Series Clutch Roller Shade

This roller shade is operated manually with a heavy-duty, self-lubricating clutch mechanism. With a continuous loop control chain, shades can be rolled up, exposing a room to sunlight, or down, filtering light from entering a room. Control chain is available as white (plastic), black (plastic), stainless steel (surcharge will apply) white stainless steel (surcharge will apply), and black stainless steel (surcharge will apply).

Standard Clutch Roller Shade Surcharges:

- Stainless Steel Chain \$ 12.00 per shade
- White or Black Stainless Steel Chain \$ 24.00 per shade
- Spring Assisted Lift \$125.00 per shade
– Spring Assist Mechanisms are required for oversized shades.
Please refer to the clutch & tube fabrication chart at the back of this section for more details.
- Fabric Wrapped Hembar \$ 15.00 per shade
- External Painted Hembar \$ 10.00 per shade
- Exterior Guide Wire System \$120.00 per shade

Minimum Width: 8"
 Maximum Width: 126"
 Minimum Height: 8"
 Maximum Height: 144"

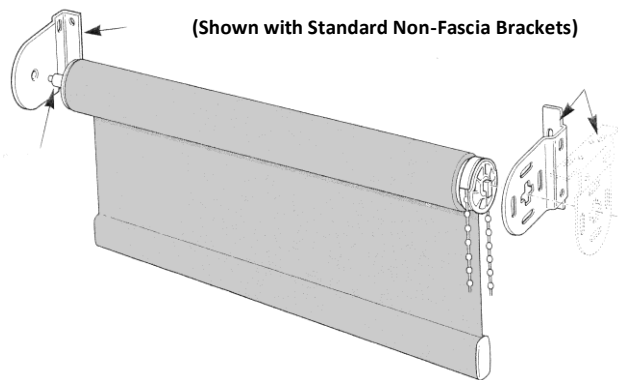

Manual Roller Shade: Cordless Spring Lift

Spring Roller Shade

This roller shade is operated by a heavy-duty spring mechanism. By pulling on a draw cord tassel attached to the hembar, shades can be rolled up, exposing a room to sunlight, or down, filtering light from entering a room. Spring Roller Shades are not recommended for large windows or commercial applications.

Minimum Width: 20"
 Maximum Width: 78"
 Minimum Height: 18"
 Maximum Height: 78"

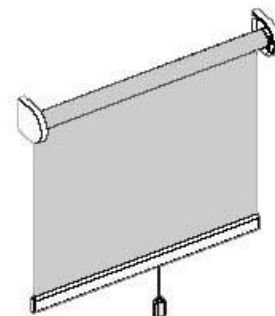

M-Series Clutch Mechanism:

Mariak's standard clutch is a heavy-duty, self-lubricating mechanism featuring the strongest spring in the industry and a continuous loop control chain. Shades can be rolled up, exposing a room to sunlight, or down, filtering light from entering a room.

Shade Dimensions:

- Minimum Width — 8"
- Maximum Width — 126"
- Minimum Height — 8"
- Maximum Height — 144"

M16 Contract Clutch
Breaking Strength
16 lbs (7.25 kg)

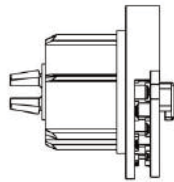

M24 Contract Clutch
Breaking Strength
24 lbs (11 kg)

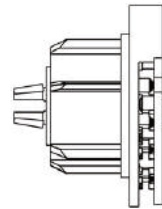

M24 Clutch Adaptor
for 2 1/2" Tube

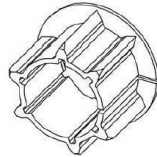

Spring Adaptor for
2 1/2" Tube

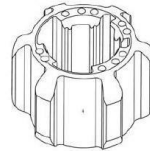

Clutch

Tube

1 1/4"	1 1/4" Aluminum
1 1/2"	1 1/2" Aluminum
1 3/4"	1 3/4" Aluminum
1 3/4"	2 1/2" Aluminum
1 3/4" Platinum Clutch with Spring Assist	2 1/2" Steel

Motor Tubes

2 1/2" Aluminum
3" Aluminum
4" Steel

Exploded Diagram of Clutch Lifting Mechanism

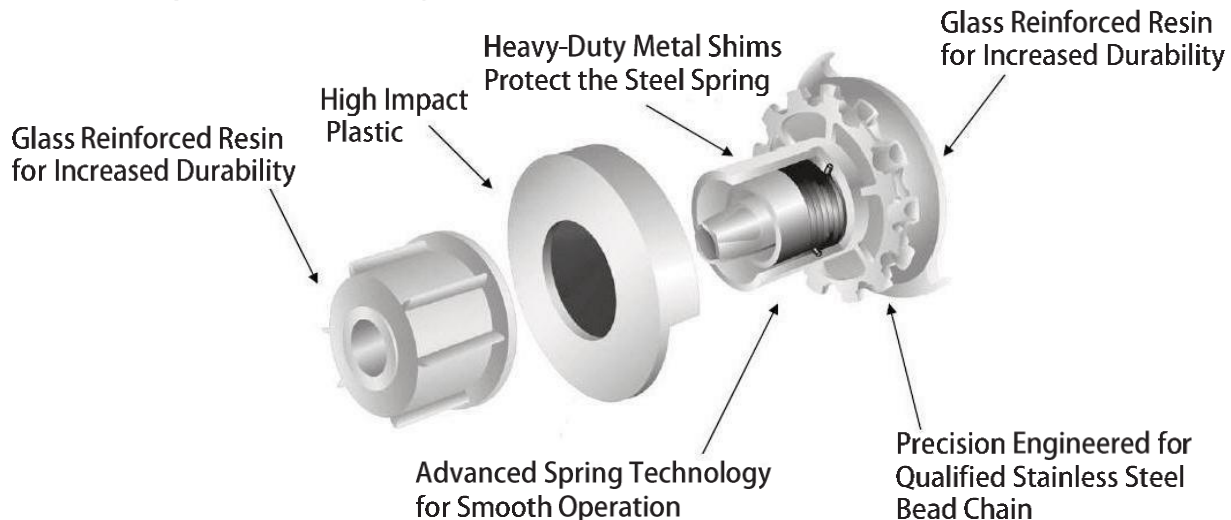

SAFE GRIP SPLINE™:

This flexible PVC extrusion establishes an effective process for securing the Roller Shade cloth to the aluminum tube. Its unique shape and composition lock the shade cloth in place, thus preventing it from falling off the tube, a common problem found when double face tape or glue techniques are applied.

The SAFE GRIP SPLINE™ creates an effective method for keeping the shade cloth straight as it rolls up on the Roller Shade tube. This system substantially reduces the amount of telescoping (the spiral motion that occurs when a Roller Shade is rolling up) that is caused when the shade brackets are installed improperly.

The SAFE GRIP SPLINE™ was developed such that it provides for easy fabric removal and installation. Should the fabric require cleaning or should the customer desire a new shade cloth, the material can be removed with ease without having to remove the Roller Shade tube from its brackets.

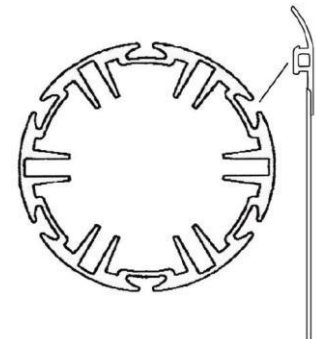

The heavy-duty commercial chain operated clutch mechanism allows precise positioning of the Roller Shade. The bi-directional clutch never needs adjustment. When the operator stops pulling on the bead chain, the clutch stops automatically, holding the shade in the exact position desired.

Features:

- 1/8"-Thick Steel Bracket
- Clutch Fixed to Installation Bracket
- Fascia Valance does not require a notch to drop through
- #10 Qualified Stainless Steel Bead Chain may be offset
- Idler End Bracket has a height-leveling adjustment
- Idler End Bracket has a ball bearing idler for quiet and ultra-smooth rotation
- Idler End Bracket available as wall or ceiling mount (must specify)
- Idler End Cap is spring-loaded and retractable for simple and easy installation
- Manufactured from PA6/glass fiber

Shade Dimensions:

- Minimum Width – 8"
- Maximum Width – 108"
- Minimum Height – 8"
- Maximum Height – 144"

Over-sized Shade Option:

- 2 1/2" Steel Tube with Platinum Series Clutch and Spring Assist.
Maximum width: 162"
Maximum length: 108"

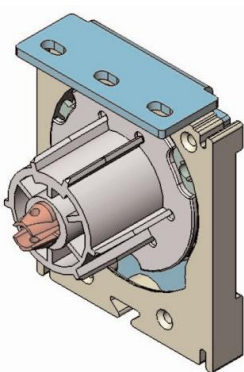
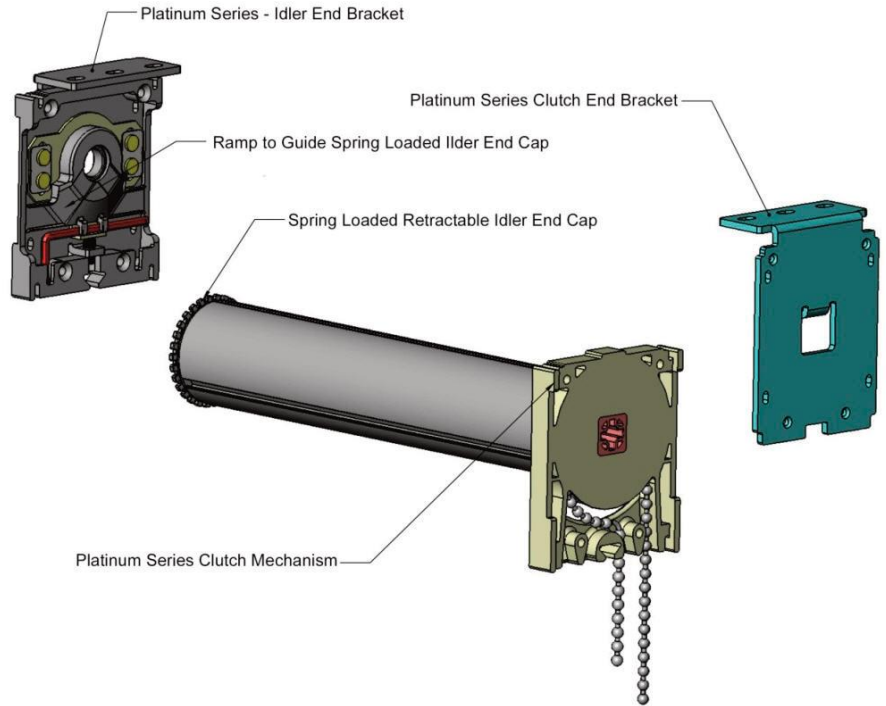

Bi-Directional Clutch with Fixed Bracket

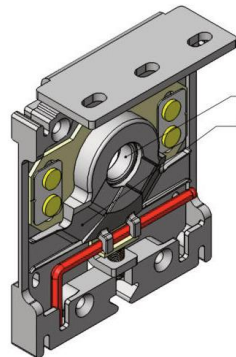

LEVEL CORRECT BRACKET™

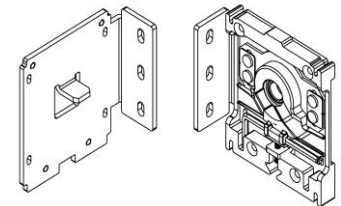
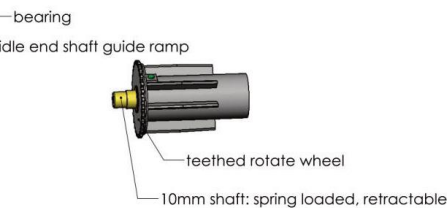

Left Hand Control Wall Mount Installation Bracket

NOTE: Ceiling or Wall Mount installation must be specified when ordering the Platinum Clutch™

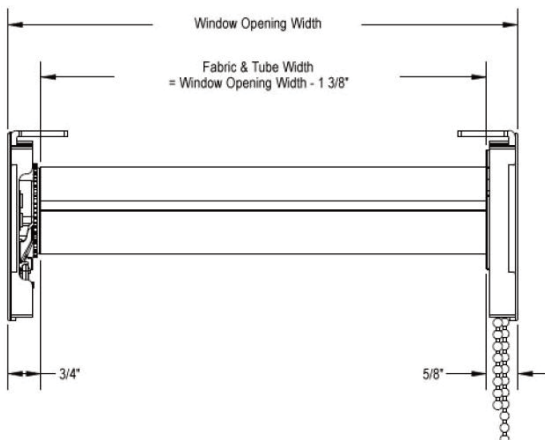

Platinum Clutch Roller Shade Surcharges:

- Platinum Clutch with Stainless Steel Chain \$ 10.00 NET per shade
- White or Black Stainless Steel Chain \$ 24.00 per shade
- Spring Assisted Lift \$125.00 per shade
– Spring Assist Mechanisms are required for oversized shades.
Please refer to the clutch & tube fabrication chart at the back of this section for more details.
- External Painted Hembar \$ 10.00 per shade

Clutch + Tube Selection Guideline

1. **IN THE LEFT HALF OF THE CHART**, find the column appropriate for the shade's fabric. Read down that column until you reach the approximate height of the shade.
2. **FOLLOW STRAIGHT ACROSS** to the right half of the chart, as far as the vertical line that represents the shade's width.
3. **THE CLUTCH AND TUBE SIZES SHOWN ARE THE MINIMUM** you may use for that shade. You may, of course, use a heavier duty clutch or a larger tube. Using a lighter clutch than recommended might lead to clutch failure. Using a smaller tube might lead to bowing of the tube.

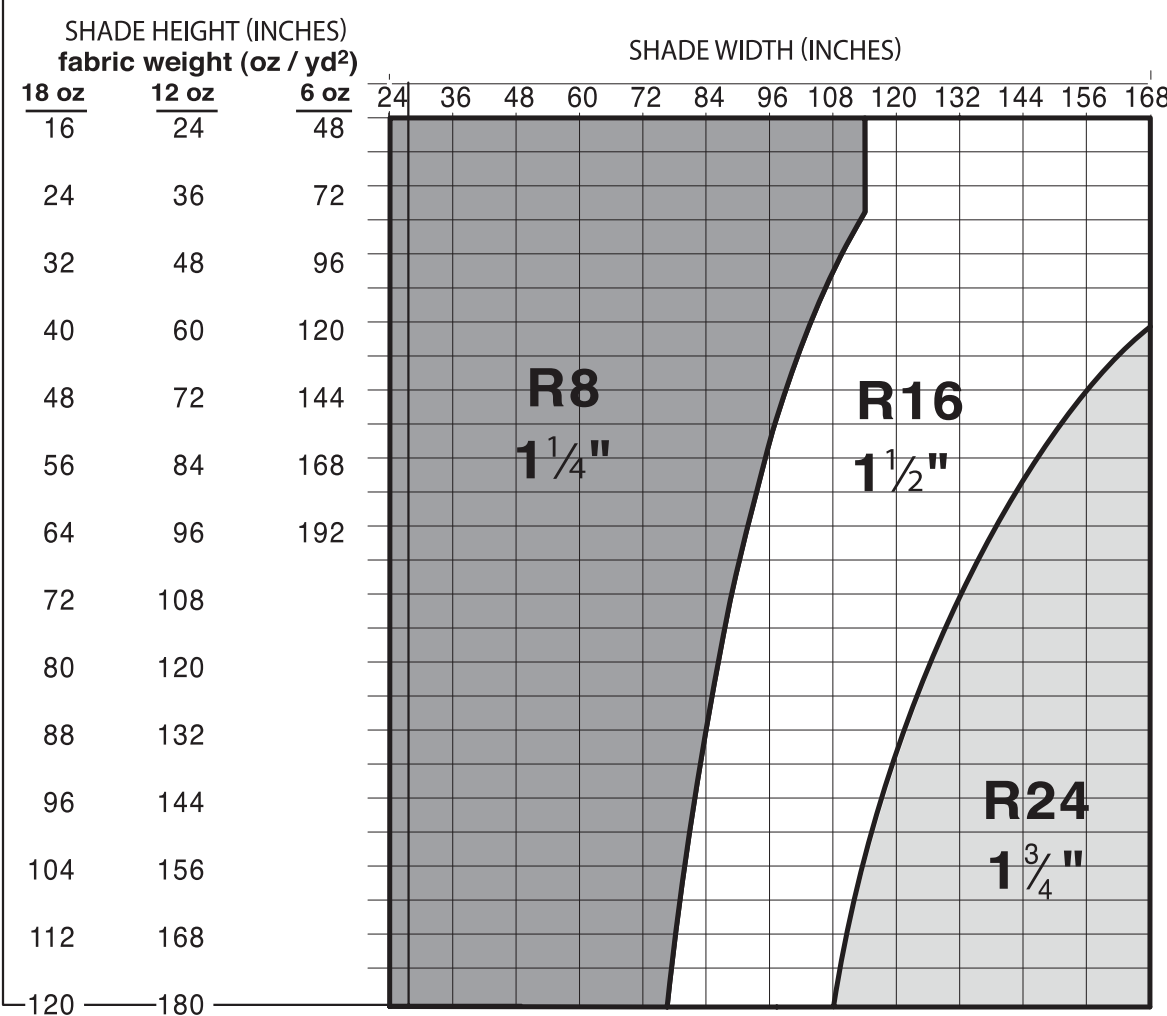

3" and 4" Square Aluminum Fascia Valance:

These "L"-shaped aluminum extrusions cover the front and bottom of the roller. Valances lock to brackets by means of snap-in fittings. The roller is concealed behind the valance and the bottom of the shade drops from the back of the valance when lowered.

- Roll: Available for regular roll only
- Color: Alabaster, Black, Bronze, White & Clear Anodized
- Mount: Inside or Outside
- Clutch: M16 (3"), M24 (4")
- Motor: DC (3" or 4"), AC (4" only)
- Minimum Width: 18"
- Maximum Width: 240"

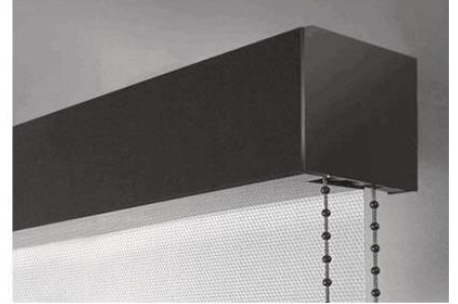
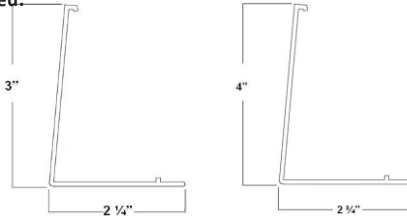

3" and 4" Round Aluminum Fascia Valance:

These aluminum extrusions offer a contoured appearance, softer than traditional square fascias. Valances cover the front and bottom of the roller and lock to its brackets by means of snap-in fittings. The roller is concealed behind this valance and the bottom of the shade drops from the back of the valance when lowered.

- Roll: Available for regular roll only
- Color: Black, Clear Anodized & White
- Mount: Inside or Outside
- Clutch: M16 (3"), M24 (4")
- Motor: DC (3" or 4"), AC (4" only)
- Minimum Width: 18"
- Maximum Width: 240"

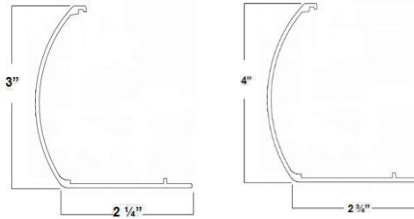

3" and 4" Fabric Wrapped Fascia Valance:

These Round Aluminum Fascia Valances include fabric matching the Roller Shade wrapped around the aluminum extrusion. Valances cover the front and bottom of the roller and lock to its brackets by means of snap-in fittings. The roller is concealed behind the valance and the bottom of the shade drops from the back of the valance when lowered.

- Roll: Available for regular roll only
- Color: Valance fabric matches shade
- Mount: Inside or Outside (Outside Recommended)
- Clutch: M16 (3"), M24 (4")
- Motor: DC (3" or 4"), AC (4" only)
- Minimum Width: 18"
- Maximum Width: 240"

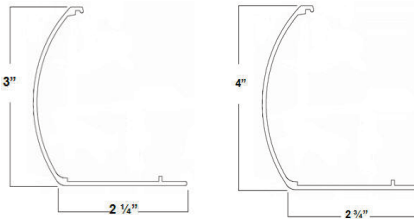

Inserted Fabric Valance

The Inserted Fabric Valance is a traditional dust cover vertical blind valance that uses 3 1/2" strips of roller shade fabric inserted into the groover channel of the valance. This valance features a continuous corner return that prevents the valance returns from separating from the valance.

- Roll: Available for regular roll & reverse roll shades
- Color: Valance fabric matches shade fabric
- Mount: Inside or Outside
- Minimum Width: 18"
- Maximum Width: 192"

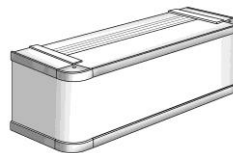

Mariak Commercial Shade Cassette:

Flat front fascia blends with internal structural shapes of commercial buildings, offering aesthetically pleasing, easy to maintain closure for Roller Shades. Snap-on brackets provide quick and easy on-site installation. Commercial quality clutch can be placed on either side of the cassette. Height-adjustable idler end allows level correction without need for shims. Cassette size 3 1/8" by 4" easily fits inside typical window openings.

Roll:	Available for regular roll only	Tube:	1 1/2" Tube up to 96" wide
Color:	Anodized, Alabaster, Black, Bronze or White		1 3/4" Tube up to 114" wide
Mount:	Inside or Outside	Min. Width: 20"	Min. Length: 20"
Clutch:	CS Clutch 16 lb.	Max. Width: 114"	Max. Length: 120"
Idle Side:	Adjustable height position Motor:		
DC			
Control:	Right or Left		

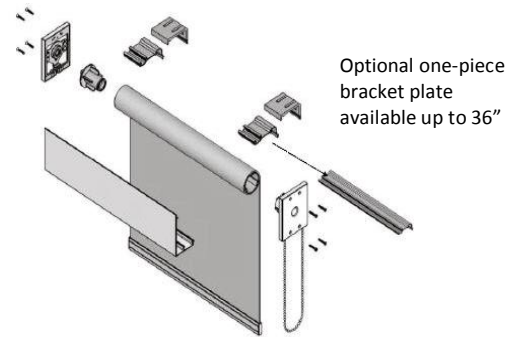

Mariak Residential Roller Shade Cassette:

For applications requiring elegant contemporary looks, Mariak Industries Inc. offers a cassette. The aluminum 3 1/2" by 3 1/2" extrusion provides space for roll of fabric up to 3 inches in diameter. Snap-on mounting brackets allow for quick installation. Front of the cassette can be finished with the shade fabric. Internal brackets allow the cassette to be used with 15 lb. clutch or DC motor.

Roll:	Available for regular roll or reversed roll
Color:	Anodized, Alabaster, Black, Bronze or White
Mount:	Inside or Outside
Clutch:	SL 15
Motor:	DC
Min. Width:	20" Min. Length: 20"
Max. Width:	96" Max. Length: 120"



LEVEL CORRECT BRACKET™ For Fascia:

The LEVEL CORRECT BRACKET™ allows installers to level the Roller Shade without removing and re-installing brackets. By removing a small allen wrench that is provided on the inside of each bracket, installers can raise or lower the idler pin end of the Roller Shade with a simple turn of a basic set screw located at the bottom opening of the fascia bracket. This bracket is available with clutch operated or motorized shades ordered with 3" or 4" fascia valances.

Bracket Dimensions:

Clutch & Bracket Used	Ceiling Mount Installation		Wall Mount Installation	
	Projection	Height	Projection	Height
3" Fascia M-Series Bracket	3"	3"	3"	3"
4" Fascia M-Series Bracket	4"	4"	4"	4"

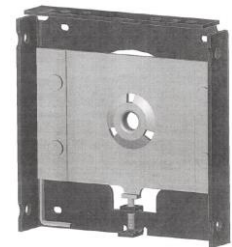

Standard Non-Fascia Bracket:

Bracket Dimensions:

Clutch & Bracket Used	Ceiling Mount Installation		Wall Mount Installation	
	Projection	Height	Projection	Height
1 1/4" M8 Clutch Bracket	1 7/8"	2 3/8"	2 3/8"	1 7/8"
1 1/2" M16 Clutch Bracket	2 7/8"	2 5/8"	2 5/8"	2 7/8"
1 3/4" M24 Clutch Bracket	3 1/4"	3"	3"	3 1/4"

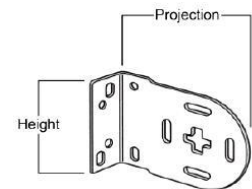

Bracket Shown as used in Wall Mount Installation

7" Dual Shade Brackets:

Bracket Dimensions:

Width: 5"
Height: 7 1/2"



Motor Dual Brackets



Manual Bracket

Standard Motor Brackets:

Bracket Dimensions:

Clutch & Bracket Used	Ceiling Mount Installation		Wall Mount Installation	
	Projection	Height	Projection	Height
Standard Motor Bracket	2 1/2"	2 7/8"	2 7/8"	2 1/2"
Fascia Motor Bracket	4"	4"	4"	4"



Fascia Motor Bracket



Standard Non-Fascia Motor Bracket

Shade Pocket with Closure Plate:

This aluminum extrusion covers the top, front and back of the Roller Shade. If installed as an inside mount, it is recommended to drill through the top of the fascia into the ceiling. If installed as an outside mount, heavy-duty brackets are provided. A 3" Bottom Closure Plate conceals the bottom of the Roller Shade.

Roll: Available for regular roll and reverse roll shades
 Color: White & Clear Anodized
 Mount: Inside or Outside
 Clutch: M16 or M24
 Motor: AC or DC
 Minimum Width: 18"
 Maximum Width: 240"
 Dimensions: 5 1/2" Deep x 5 3/8" Tall

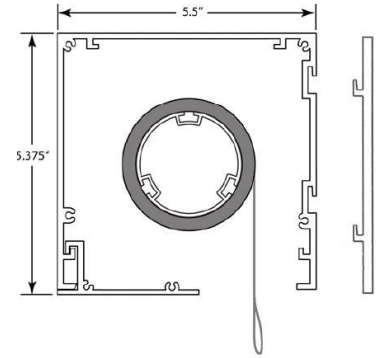

Shade Pocket with Closure Plate & Ceiling Tile Receiver:

Aluminum extrusion covers the top, front and back of the Roller Shade. This valance is generally mounted above the ceiling and ceiling tiles rest on the receiver lip at the front edge of the extrusion. A 3" Bottom Closure Plate conceals the bottom of the Roller Shade.

Roll: Available for regular roll and reverse roll shades
 Color: White & Clear Anodized
 Mount: Inside or Outside
 Clutch: M16 or M24
 Motor: AC or DC
 Minimum Width: 18"
 Maximum Width: 240"
 Dimensions: 5 1/2" Deep x 5 3/8" Tall

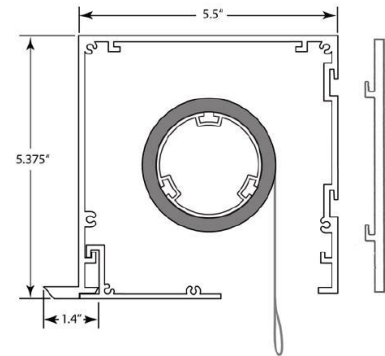

Wall Hanger with Closure Plate for Dry Wall Pocket:

A 3" Bottom Closure Plate conceals the bottom of the Roller Shade.

Roll: Available for regular roll and reverse roll shades
 Color: White
 Mount: Inside
 Clutch: M16 or M24
 Motor: AC or DC
 Minimum Width: 18"
 Maximum Width: 240"
 Dimensions: Customizable per user specification

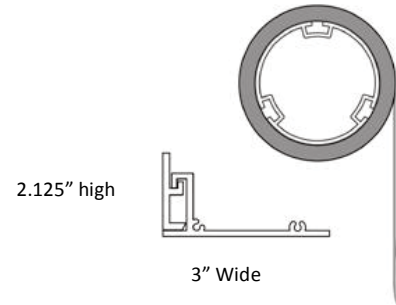

Dual Shade Pocket with Closure Plate:

Aluminum extrusion covers the top, front and back of a dual Roller Shade system. If installed as an inside mount, it is recommended to drill through the top of the fascia into the ceiling. If installed as an outside mount, heavy-duty brackets are provided. A 3" Bottom Closure Plate conceals the bottom of the Roller Shade.

Roll: Available for regular roll and reverse roll shades
 Color: White
 Mount: Inside or Outside
 Clutch: M16 or M24
 Motor: AC or DC
 Minimum Width: 18"
 Maximum Width: 240"
 Dimensions: 7" Deep x 9" Tall

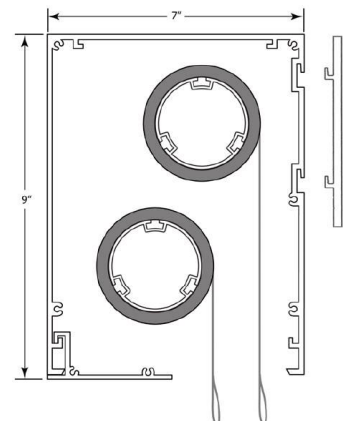

Roller Shade Hembar & Channel Options:

Pocket Bottomweight Hembar (Standard)

The Pocket Bottomweight Hembar is an aluminum extrusion welded into a pocket made by folding over the fabric at the bottom of the roller shade. This type of hembar is commonly referred to as a concealed hembar and is standard on roller shades.

Size: 1 3/8" tall

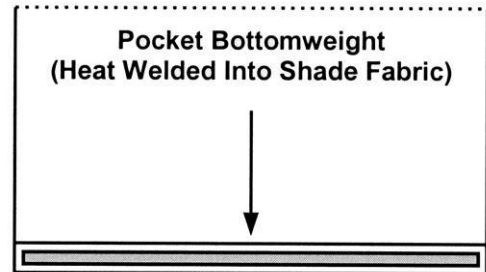
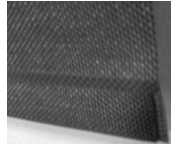

External Hembar

The External Hembar is an exposed, hollow aluminum extrusion secured to the bottom of the roller shade fabric. The ends are covered with plastic, color coordinating caps that are fixed in place with screws. This hembar option is available in white, black, bronze, and clear anodized finishes. The Wrapped Hembar is required when hold-downs are requested and for exterior shades along with stainless steel chain.



Upgrade Surcharge:

- External Hembar \$ 10.00 per shade

Wrapped Hembar

The Wrapped Hembar is an exposed aluminum extrusion in which the shade fabric is wrapped around the front of the hembar locked into place at the top and bottom of the extrusion. The Wrapped Hembar is required when hold-downs are requested and is required for the exterior shade guide wire system.



Upgrade Surcharge:

- Fabric Wrapped Hembar \$ 15.00 per shade

Spring Assist for Oversized Shades:

Mariak Contract offers an optional Spring Assist Clutch Lifting Mechanism, which allows the operator to lift heavy and oversized shades that exceed \pm 85 sq. ft. A Spring Assist is required for very large shades, but it can be added to smaller shades as well, ensuring lift operation with additional ease. The Spring Assist Clutch assembly includes a heavy-duty wrapped spring that attaches directly to an M16 or M24 clutch mechanism by means of a snap-fit and fixing screw. Shades using a Spring Assist Clutch Mechanism may be operated as left- or right-hand control. Spring Assist is available with Regular Roll and Reverse Roll options.

Spring Assisted Shades **\$125.00 per shade**
 – Please refer to the Clutch/Tube fabrication table at the back of this section to determine when a Spring Assist Lift Mechanism is required.
 – Shades with Spring Assist Mechanisms are available for both right and left hand control

Recommended Sizes:
 Minimum Width: 60"
 Maximum Width: 126"
 Minimum Height: 60"
 Maximum Height: 144"

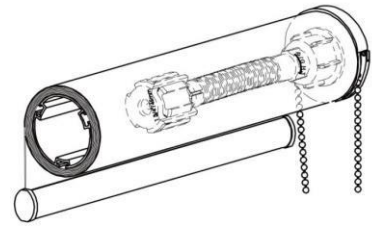

Multiple Roller Shades:

Multiple-Band M-Series Clutch Roller Shade with Single Control:

This type of Roller Shade joins two fabric bands and allows operation on a single control chain. This intermediate bracket uses a sealed roller bearing with recessed end caps to reduce light gap between the two fabric panels. Fascia is not available with this option.

- Note:**
- Due to weight constraints, a maximum of two shade bands can be controlled from a single control chain
 - 1 Inch Light Gap at Center Bracket
 - Available for use with both 1 1/2" and 1 3/4" clutch mechanisms

Maximum Width: 16'
 Maximum Combined Width: 96'
 Minimum Height: 8'
 Maximum Height: 96' **Surcharge: \$15.00 Net Per Shade**

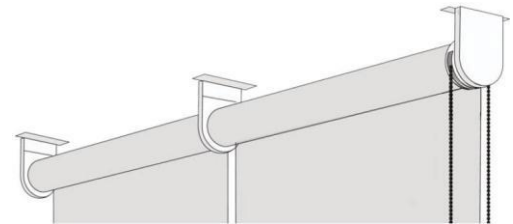

M-Series Clutch Roller Shade with Split Control & Center Support Bracket:

This specially designed bracket joins two separate Roller Shades together. It allows operation of two independently operated shades with two control chains. The right chain operates the right shade, while the left chain operates the left shade. This center support bracket uses two recessed spring loaded end caps to reduce light gap between the two separate Roller Shades. Fascia is not available with this option.

- Note:**
- Available for use with both 1 1/2" and 1 3/4" clutch mechanisms

Maximum Width: 16' Minimum Height: 8'
 Maximum Combined Width: 192' Maximum Height: 96'

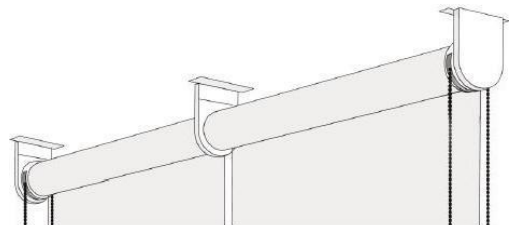

Surcharge: \$15.00 Net Per Shade

How to measure for Multiple-Band Roller Shades:

Measure from outside-bracket to outside-bracket to get the overall width. Measure from the left edge to the center point; then measure from the center point to the right edge.

Side & Sill Channels:

Side and Sill Channels are a 2-piece, "U"-shaped aluminum extrusion used to eliminate light gaps at the right, left and bottom edges of the Roller Shade. These channels are primarily used for applications where complete blackout of light is desired.

Roll: Available for regular roll and reverse roll shades
 Color: White, Alabaster, Bronze, Black and Clear Anodized
 Mount: Inside or Outside
 Minimum Length: 18'
 Maximum Length: 240'
 Dimensions: 2 1/4" wide x 15/16" deep

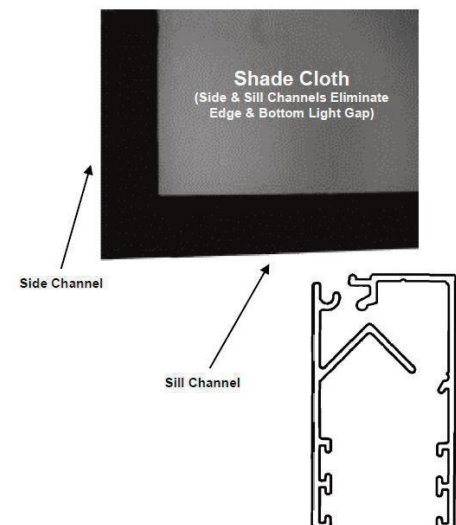

EXTERIOR GUIDE CABLE INSTALLATION INSTRUCTIONS CLUTCH OPERATED SHADE

Cable guide should be installed between the window and motor and idler bracket for regular roll and in front of the bracket for reverse roll shade installation.

1. Attach the clutch and idler brackets to the wall or ceiling. Attach tensioning cable to the buckle on the bracket. Make sure the cable is on the inside of the bracket between the wall and the shade fabric as shown on Pic. 1.

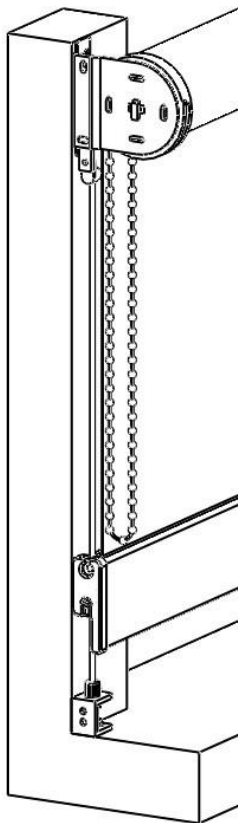
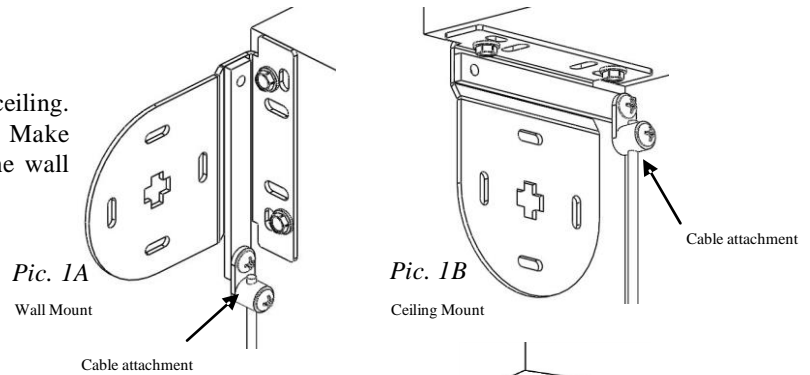

2. With the shade lowered all the way down, stretch the cable vertically to find the best position for the hold down bracket. Attached the U hold down bracket to the wall or a floor. Make sure the U brackets is vertically below the upper brackets and there are no obstacles between them.

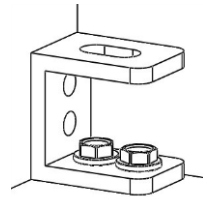

Pic. 2

3. With the tensioning cable stretched, secure it in place with the set screw as shown in Pic. 3. Slide the bolt through the upper opening in the U bracket and tighten it with the tensioning nut.

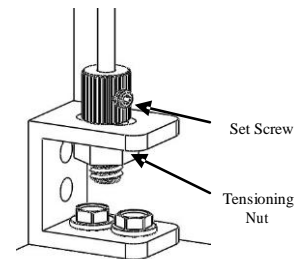

Pic. 3

4. Repeat steps 1 to 4 for the opposite side of the shade.

5. Lower and raise the shade making sure the cables are not binding and hem bar is sliding smoothly. Pic. 4

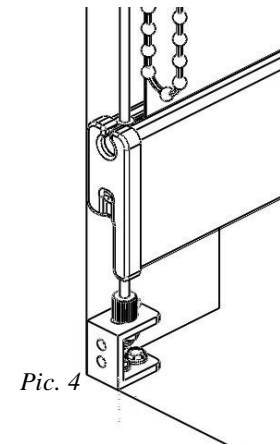

Pic. 4

Available in White Only.

Note: Fascia is required with this system for an additional cost.

M-Series Clutch Dual Shade Without Fascia:

This Roller Shade allows installation of a Sunscreen fabric shade and a blackout shade on a single mounting bracket providing both light filtering and room darkening. The compact bracket design permits two shades to fit in a smaller room projection than two individually installed shades on the same window.

Bracket Dimensions:	4 1/2" x 4 1/2"
Control Option:	Both Front & Back Shades with Left Side Controls Both Front & Back Shades with Right Side Controls
Clutch:	Available for use with 1 1/2" clutch mechanism only. Color:
Available in White only	
Minimum Width:	8"
Maximum Width:	96"
Minimum Height:	8"
Maximum Height:	96"

Double Bracket Surcharge:
\$ 20.00 Net Per Pair

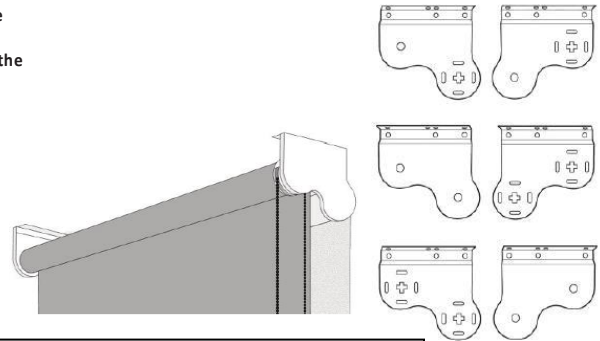

Note: When installing double shade brackets as a wall mount application, the front roller shade must be ordered as a reverse roll.

M-Series Clutch Dual Shade With 4" and 7 1/2" Square Fascia:

For applications where both Sunscreen and Room Darkening shades are required, the 4" and 7 1/2" Square Aluminum Fascia Valances offer a solution. These "L"-shaped aluminum extrusions cover the front and bottom of the front-most Roller Shade. These valance accessories lock to their brackets by means of snap-in fittings. The front roller is concealed behind the valance and the bottom of the shade drops from the back of the valance when lowered.

Roll:	Available as regular roll only
Mount:	Inside or Outside
Bracket Dimensions:	4" Fascia – 4" tall x 5 3/4" Deep 7 1/2" Fascia - 7 1/2" tall x 5 3/4" Deep
Finishes:	7 1/2" Fascia - White, Bronze & Clear Anodized Only 4" Fascia – Alabaster, Anodized, Black, Bronze & White
Control Option:	Both Front & Back Shades with Left Side Controls Both Front & Back Shades with Right Side Controls
4" Double Fascia Bracket Surcharge:	\$30.00 Net Per Pair
Note:	Available for use with 1 1/2" M16 clutch mechanism only.
7-1/2" Double Fascia Bracket Surcharge:	\$60.00 Net Per Pair

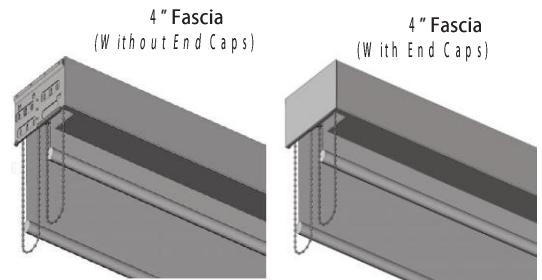

	4" Fascia	7 1/2" Fascia
Minimum Width:	8"	8"
Maximum Width:	96"	144"
Minimum Height:	8"	8"
Maximum Height:	96"	156"

Motorized Dual Shade Without Fascia:

Typically installed into a pocket built into the ceiling.

Bracket Dimensions: 7 1/2" Height x 5" Depth

Shade Dimensions:
Minimum Width: 18"
Maximum Width: 160"
Minimum Height: 18"
Maximum Height: 192"

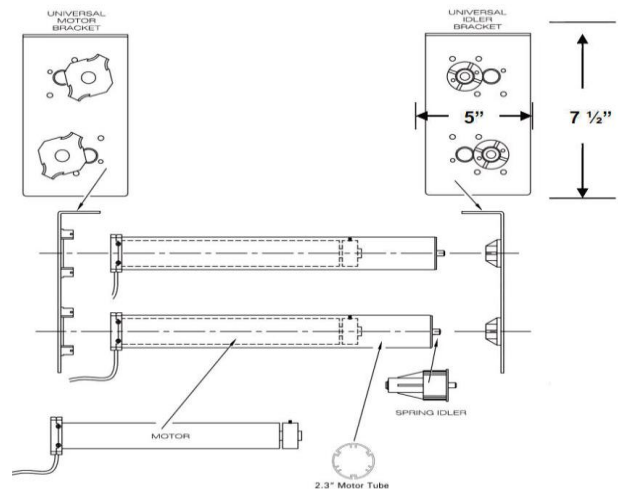

Motorized Dual Shade With 4" and 7 1/2" Square Fascia:

This type of Roller Shade allows installation of a Sunscreen shade and a room darkening shade on a single mounting bracket providing both light filtering and light blocking. The compact design of this bracket permits two shades to fit in a smaller room projection than two individually installed shades on the same window.

Roll:	Available for regular roll only
Mount:	Inside or Outside
Motors:	DC (4" Fascia), AC or DC (7 1/2" Fascia)
Minimum Width:	18" (4" Fascia), 36" (7 1/2" Fascia)
Maximum Width:	96" (4" Fascia), 126" (7 1/2" Fascia)
Minimum Height:	18" (4" Fascia), 24" (7 1/2" Fascia)
Maximum Height:	96" (4" Fascia), 192" (7 1/2" Fascia)

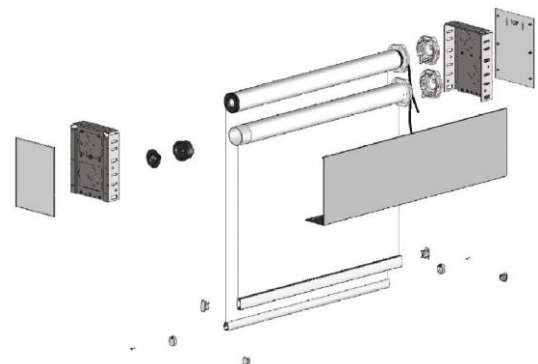

Motorized Roller Shade: RTS Wirefree Battery Powered

Battery Powered Motorized Roller Shade

This roller shade is operated by a battery powered motor system. At the press of a button, shades can be rolled up, exposing a room to sunlight, or down, filtering light from entering a room. This unique motor system has full lift control of shades that are up to 12.5 lbs. The motor is powered by AA lithium battery packs, which can be concealed within a valance, mounted to the ceiling, or installed to the wall. The battery life expectancy is 1 to 2 years (based upon 4 operations per day and the weight of the shade). Battery powered roller shades are available with radio frequency controls. Shades may be operated as an individual unit, as sub-groups, and as an entire group. Please consult Mariak technical support with any questions you may have.

Battery Powered Roller Shade Surcharges: Batteries are included with motors & controls.

• RF Battery Motor – 12-volt	\$625.00 per shade (For shades up to 12.5lbs.)
• Radio Frequency Transmitter 1-Ch	\$140.00
• Radio Frequency Transmitter 5-Ch	\$175.00
• Radio Frequency Transmitter 16-Ch	\$515.00
• Radio Frequency Wall Switch 1-Ch	\$320.00
• Radio Frequency Wall Switch 5-Ch	\$340.00
• Radio Frequency 24-Hour Chronis Timer	\$360.00
• Radio Frequency Sunis Interior Sun Sensor	\$410.00
• Radio Frequency 16 –Ch Interface for Automation Integration	\$900.00



RF Hand-Held Transmitters & Wireless Wall Switches are available in 1 & 5 Channel models

Minimum Width:	14"
Maximum Width:	96"
Minimum Height:	18"
Maximum Height:	96"

Critical Note: Included in the surcharge for a Battery Motorized Shade is a set of Dual Battery Packs with 16 AA Lithium Batteries.

Battery Packs Mounted to the Top of the Window Jam

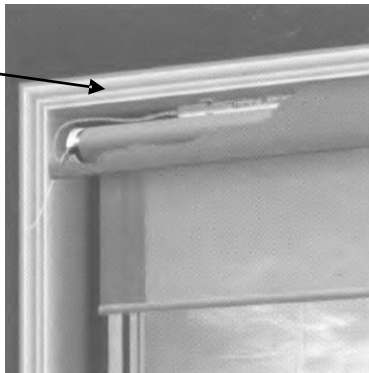

WireFree™ Solar Pack:

The new WireFree solar pack harnesses renewable solar energy to power WireFree motorized window coverings. This latest innovation from Somfy sheds new light on WireFree motorized window coverings by offering the following features:

- Patented energy saving technology uses sunlight to power the motorized window covering(s)
- Convenient and cost effective — reduces battery replacement and preserves the environment.
- Easy to install for new and existing window coverings.
- Low profile solar (photovoltaic) panel is discreet and easy to conceal.

Solar Pack in Window

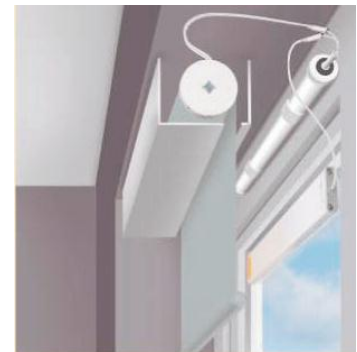

Motorized Roller Shade: RTS Plug-In (AC & DC options)

Plug-In/Radio Frequency (RTS) AC & DC Motorized Roller Shade – Motorization Made Simple!

Depending on the size and electrical wiring available, this roller shade is operated by either a 110-volt AC 3-wire motor or a 24-volt DC 2-wire motor. This scenario requires the motor to be plugged-in to a standard 3-prong electrical wall outlet. For your convenience, if a 110-volt AC motor is selected, the shade is shipped from the factory with a plug installed at the end of the motor cable. If so desired, the plug may be cut off and hardwired to a dedicated power supply by a licensed electrician. If the 24-volt DC motor is specified, you will need to wire the power supply transformer to the motor cable. Plug-in motors have a built-in radio frequency receiver that communicates with a variety of remote control transmitters via radio waves. At the push of a button, shades can be rolled up, exposing a room to sunlight, or down, filtering light from entering a room. The electronic controls for plug-in motorized roller shades are capable of operating a shade individually, as sub-groups, and/or as an entire group. Please consult Mariak technical support with any questions you may have.

110-Volt AC Motorized Shades

Minimum Width: 29"
 Maximum Width: 240"
 Minimum Height: 18"
 Maximum Height: 240"

24-Volt DC Motorized Shades

Minimum Width: 18"
 Maximum Width: 96"
 Minimum Height: 18"
 Maximum Height: 96"

Plug-In/Radio Frequency Motorized Roller Shade Surcharges:

Please note that Radio Frequency motors have 3-wire conductor cables.

These motors may be hardwired or plugged into a 3-prong electrical outlet.

110v AC Somfy RTS Motor Options:

- Radio Frequency Sonese 50 RTS Motor – 504 Model \$ 755.00 per shade (For shades up to 25lbs.)
- Radio Frequency Altus 50 RTS Motor – 506 Model \$ 815.00 per shade (For shades up to 35lbs.)
- Radio Frequency Altus 50 RTS Motor – 510 Model \$ 935.00 per shade (For shades up to 60lbs.)

24v DC Somfy RTS Motor Options: (Power supply transformers are required for DC Motors)

- Radio Frequency Sonese 30 RTS Motor \$ 755.00 per shade (For shades up to 15lbs.)
- 1.66amp Power Supply (Powers 1 24v motor) \$ 42.86 NET
- 5.00amp Power Supply (Powers up to 3 24v motors) \$ 172.81 NET
- 10.0amp Power Supply (Powers up to 6 24v motors) \$ 335.66 NET
- 15.0amp Power Supply (Powers up to 9 24v motors) \$ 416.46 NET
- 20.0amp Power Supply (Powers up to 12 24v motors) \$ 975.86 NET

(Critical Note: Power Supply are only required when ordering 24-volt DC motors. Do not order power supplies with 110-volt motors).

Somfy Altus RTS Control Systems: (Selected at least 1 Transmitter or Wall Switch)

- Radio Frequency Transmitter 1-Ch \$140.00
- Radio Frequency Transmitter 5-Ch \$175.00
- Radio Frequency Transmitter 16-Ch \$515.00
- Radio Frequency Wall Switch 1-Ch \$320.00
- Radio Frequency Wall Switch 5-Ch \$340.00
- Radio Frequency 24-Hour Chronis Timer \$360.00
- Radio Frequency Sunis Interior Sun Sensor \$410.00
- Radio Frequency 16 –Ch Interface for Automation Integration \$900.00



RF Hand-Held Transmitters & Wireless Wall Switches are available in 1 & 5 Channel models



110-volt AC Plug-In Motors simply plug directly into a standard electrical outlet



24-volt DC Plug-In Motors require a power supply transformer that is wired to the motor cable and then plugs into an electrical outlet

Plug-In Motors Plug Into a Standard Electrical Outlet located somewhere close to the motor.

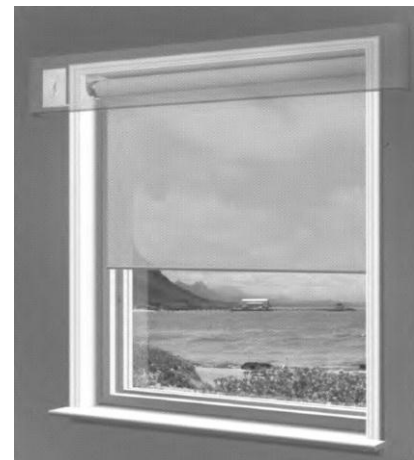

Econoline Motor

Mariak Industries Inc. introduces the Econoline Motor exclusively designed and produced for the North American Market.

Features include:

- Quiet Motor
- 110 Volts – 115 Watts
- AC Plug-In Motor Only with 6' Cord
- 6-Newton Motor Strength
- Radio Control
- Lifting Capacity of 50 Pounds (Approximately 15' x 12' depending on fabric weight)
- Programmable from Remotes – 3 available (Wall Switch Not Available)
- Diameter – 35mm
- 5 Year Limited Lifetime Warranty
- Durability
- Fits 2" and 3" Mariak Tube
- Quiet Rubber Drive
- 20" Motor Body Allows for Narrow Shade Installation
- Motor Works with Universal Bracket - 10 mm Square Stud
- Speed – 34 rpm
- Thermal Time – 4 Minutes
- Maximum Operable Temperature – 40° C = 104° F
- Power Consumption – 0.96A
- RF Antenna – External
- Motor Cord Length with Nema Plug – 6 Feet
- Light Gap 7/8" on each side
- Minimum Shade 23-1/2" Wide

110v AC Mariak Econoline Motor Options:

- Radio Control/Plug-In Motor with 6' Cord & Nema Plug \$ 540.00 per shade
- 1-Channel Econoline Transmitter \$ 60.00 each
- 6-Channel Econoline Transmitter \$ 150.00 each
- 16-Channel Econoline Transmitter \$ 250.00 each

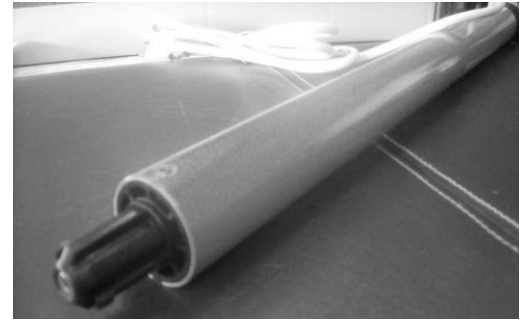

Programmable from One, Six or Sixteen Channel Remote.

UL Listed Motors



Mariak Window Fashions features a full line of UL Listed motors, controls, boxes and components from ESI that are made in the U.S.A.



Coming Winter 2014!

- APP Control
- Remote Access
- Timed Events
- On-Screen Setup Wizard
- Flexible Compatibility
- \$500.00
- mylink.somfy.com

Motorized Roller Shade: In-Wall Hardwired

In-Wall Hardwired Motorized Roller Shade

This roller shade is operated by a 110-volt AC 4-wire motor. It requires the motor to be hardwired or installed such that the power supply must be fixed and permanent. In other words, wires from a power source within the wall must be connected by a licensed electrician so that the motor receives a constant power supply at all times. At the push of a button, shades can be rolled up, exposing a room to sunlight, or down, filtering light from entering a room.

The electronic controls for hardwired motorized roller shades are capable of operating a shade individually, as sub-groups, and/or as an entire group. Please consult Mariak technical support with any questions you may have.

Minimum Width: 29"
 Maximum Width: 240"
 Minimum Height: 24"
 Maximum Height: 240"

Hardwired Standard Motorized Roller Shade Surcharges:

Please note that Hardwired Standard motors have 4-wire conductor cables.

Motor Options: (Select one motor per shade)

- Somfy Sonese Standard Hardwire Motor – 504 Model..... \$655.00 per shade (Silent Motor for shades up to 25lbs.)
- Somfy LT50 Standard Hardwire Motor – 506 Model.....\$655.00 per shade (For shades up to 35 lbs.)
- Somfy LT50 Standard Hardwire Motor – 510 Model.....\$735.00 per shade (For shades up to 60 lbs.)
- Motion Control (MCS) Hardwired Motor – 506 Model.....\$550.00 per shade (For shades up to 35lbs.)
- Motion Control (MCS) Hardwired Motor – 512 Model..... \$700.00 per shade (For shades up to 60lbs.)

Standard Paddle Wall Switches:

- Maintained SPDT Wall Switch..... \$ 65.00 (For individual motor control, 1 required per motor)
- Maintained DPDT Wall Switch..... \$130.00 (For group control of 2 motors, 1 required for 2 motors)

Additional Hardwired Motor Accessories:

- Plug Disconnect w/Wall Entry Plate..... \$ 32.00 net



There are a number of hardwired motor control options. Please consult Mariak technical support so that we may help you create the best solution for your job requirements.

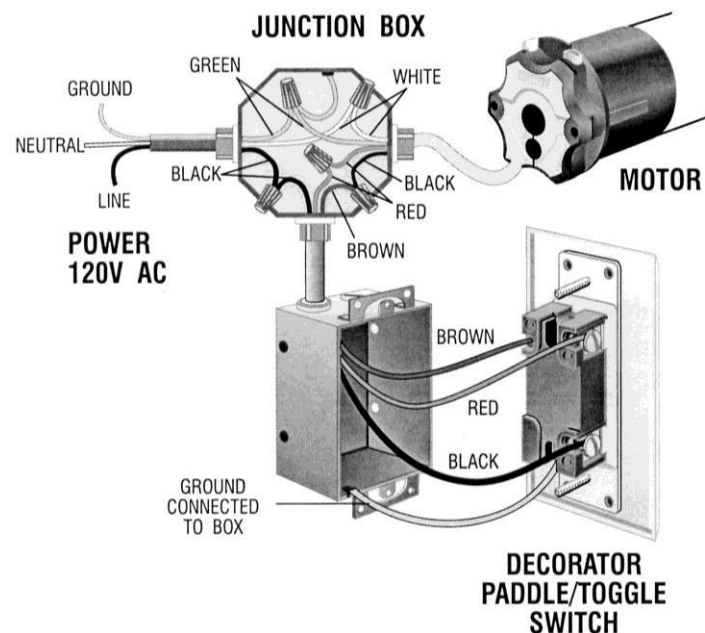

In-Wall Hardwired with Plug Disconnect
 (Plug Disconnect is available for an additional charge)

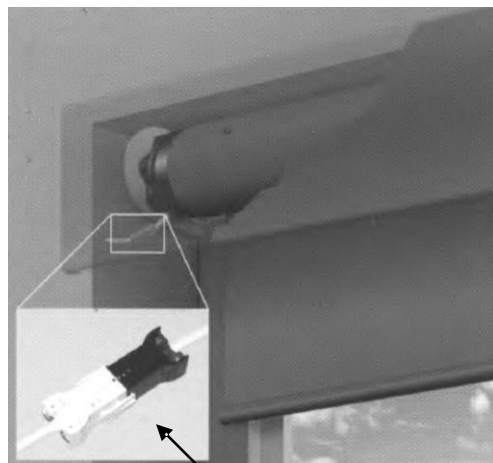

Example of Plug Disconnect

Multiple-Banded Coupled Motorized Roller Shades:

Multiple-Banded Coupled Motorized Shades:

A multiple-banded shade is a set of individual shades (generally 2 to 5 fabric bands) that are connected together by shade coupler brackets. These fabric bands are all run off of an individual motor. In other words, 1 motor can operate anywhere from 2 to 5 shade bands at one time. Please note that for this application, shades cannot be controlled individually; each set of coupled shades will always raise and lower together in unison. A multiple-banded shade application reduces the number of motors required for a given job and eliminates additional wiring expenses that might have been required for additional motors.

Note: The maximum size of the overall shade and the number of shade bands is subject to weight limitations of an individual motor.

Positive Reasons for using Multiple-Banded Shades:

- Reduction of motor costs
- Reduction of electrician costs
- Break up very large shades into smaller ones

Negative Reasons for not using Multiple-Banded Shades:

- More complex bracket installation
- Group control of shades only
- All shades must be the same height

Pricing: Multi-band shades are priced by adding the shade price for each band together. Then separately and add together

1. Price each band separately and add together
2. Price each coupler surcharge and add together
 - a. Straight Line Coupler Bracket Surcharge \$100.00 per Coupler
 - b. Corner Coupler Bracket Surcharge (90° Adjustable) \$200.00 per Coupler
3. Add shade band and coupler prices together

Straight Multiple-Banded Shade System:

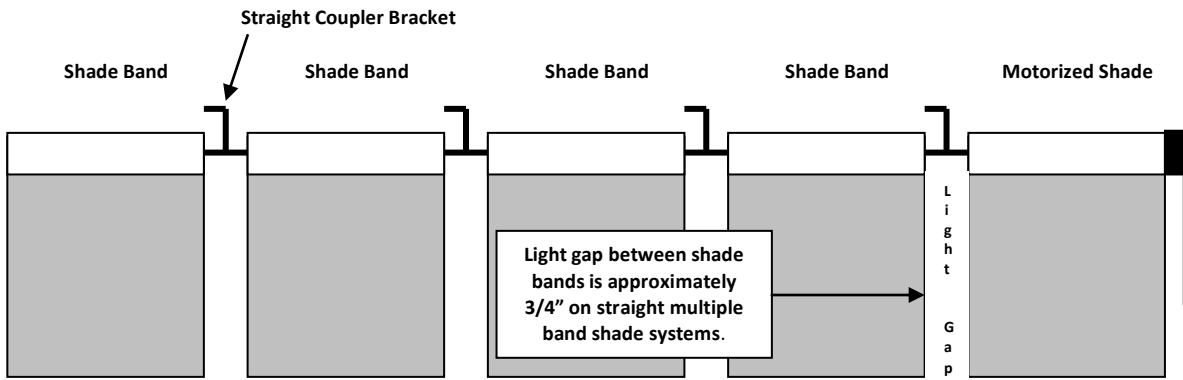

On a Multiple-Banded Shade, all shade bands will always raise and lower together.

Mariak AC Motorized Multiple-Banded Coupled Shades

Corner Multiple-Banded Motorized Shades:

**Corner Coupler Brackets are
Adjustable from 5° to 90°
As little as 1-1/2" light gap between 2 shades**

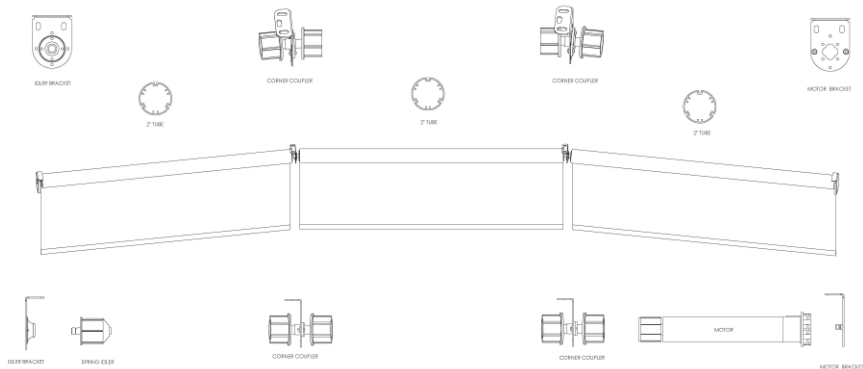
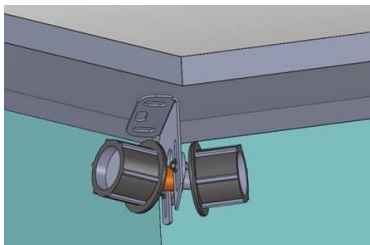



The SDN System is a standard half duplex, bi-directional RS-485 network. Bi-directional communications make it possible to receive feedback from each motor on the network. This allows the system to view the position and status of any motor on the network, in real time. Since the SDN network runs over standard network architecture, it is possible to establish a remote connection to the system from anywhere internet access is available. This defines a new level of commissioning and support services that can be offered for today's energy efficient Intelligent Building.

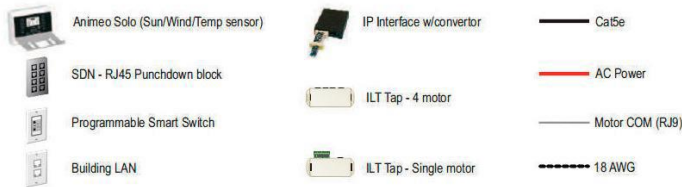
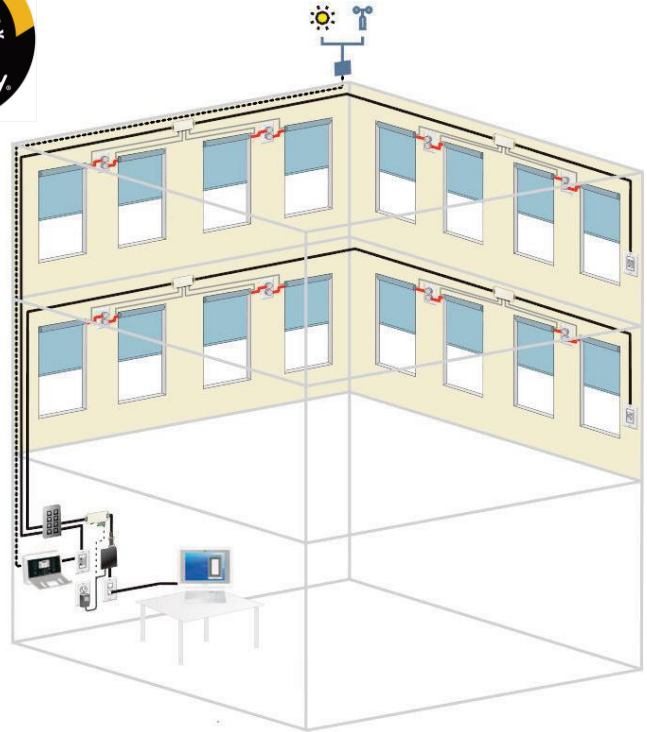

Wall Switch



Hand-Held Remote Control Transmitter



24-Hour Timer



Sun Tracking Controls



Wind Sensor Controls



Computer Integration Controls

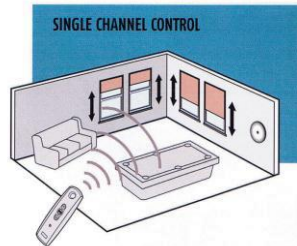

SINGLE CHANNEL CONTROL

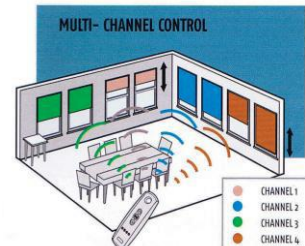

MULTI- CHANNEL CONTROL



- Unique Network Address for selective control of individual motors
- Communication via RS-485 Network
- Individual & Group Control with 16 customizable pre-set positions
- Dry Contract, IR, RTS, RS-232, RS-485, & Z-Wave allow simple integration with 3rd Party Automation System
- Easily add ILT Motors and Smart Controls to meet changing application requirements

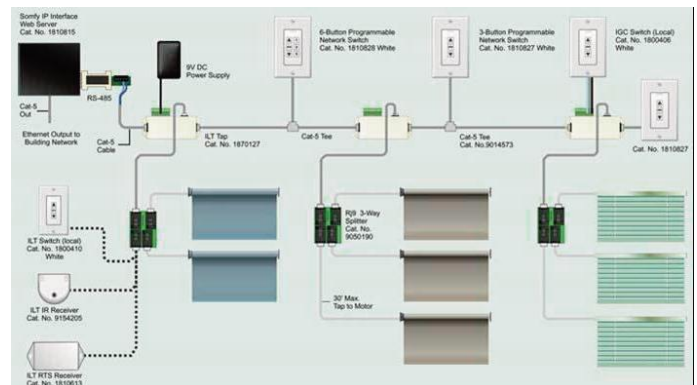

Motorized Bottom-Up Shade with Motor and Fabric on the Bottom:

Mariak's Bottom-Up Shade can be configured with both fabric and the motor on the bottom. The fabric on the tube is placed closer to the window while the motor winding cables is placed away from the window. Both the fabric and the motor tube are suspended from one 5 1/2" by 7 3/8" bracket. Rectangular end caps cover both ends while the aluminum fascia covers the top. A pulley system guides the cable from the motor tube to the top of the window and down to the hem bar finishing the shade. Cables could be placed at the end of the shade or follow the mullions.

Roll:	Available for reversed roll only		
Color:	White		
Mount:	Inside or Outside		
Motor:	AC		
Control:	Right or Left		
Minimum Width:	30"	Minimum Length:	30"
Maximum Width:	144"	Maximum Length:	180"

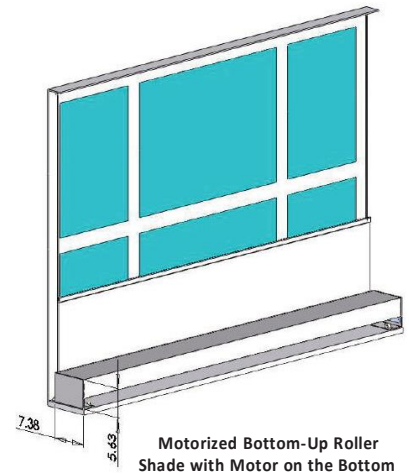
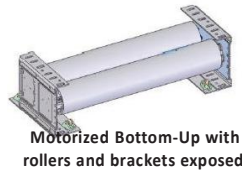

Specifications:

Electric Motor: Tubular AC motor, lifetime lubricated, instantly reversible, thermal overload protector and electric brake.

Hardware:

- Roller tubes – 6063 T6 extruded aluminum reinforced with ribs
- Spring take up – Industrial quality 2 3/4" roller with heavy duty .090" wire spring
- Idlers – Nylon 6 body with zinc plated steel pin
- Brackets – Industrial quality zinc plated 14 gauge steel
- End caps – 6063 T5 extruded aluminum .100" thick.
- Head box – 6063 T5 aluminum extrusion
- Tension wire – Type 302/304 Stainless Steel Wire, Ø.063 Braking Strength 270 lb.

Motorized Bottom-Up Shade with Motor on the Top:

Mariak's Bottom-Up Shade can be configured with a motor on top and still deploy from the bottom of the window. Fabric rolled on the tube is placed inside of the aluminum enclosure. Cables pulling the hembar are secured to the upper tube, which contains the lifting AC motor. The upper tube is mounted on the brackets and concealed in an upper aluminum enclosure at the top of the window. Lifting cables are typically attached at the ends of the hembar to provide clear view or they follow the mullions of the window per customer specification. Optional snap-on side channels are also available for this product. Typically 4 1/2" by 4 1/2" "L" fascia are used as an enclosure.

Roll:	Available for reversed roll only		
Color:	White		
Mount:	Inside or Outside		
Motor:	AC		
Control:	Right or Left		
Minimum Width:	30"	Minimum Length:	30"
Maximum Width:	144"	Maximum Length:	180"

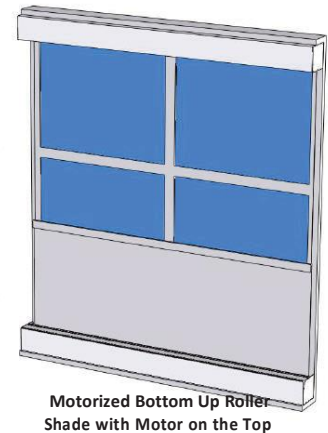
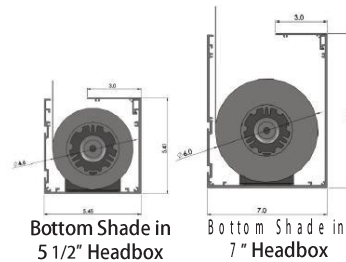

Specifications:

Electric Motor: Tubular AC motor, lifetime lubricated, instantly reversible, thermal overload protector and electric brake.

Hardware:

- Roller tubes – 6063 T6 extruded aluminum reinforced with ribs
- Spring take up – Industrial quality 2 3/4" roller with heavy duty .090" wire spring
- Idlers – Nylon 6 body with zinc plated steel pin
- Brackets – Industrial quality zinc plated 14 gauge steel
- End caps – 6063 T5 extruded aluminum .100" thick.
- Head box – 6063 T5 aluminum extrusion
- Tension wire – Type 302/304 Stainless Steel Wire, Ø.063 Braking Strength 270 lb.

Standard Skylights with Snap-On Side Channels:

Manual Standard Skylight:

An "L"-shaped 4 1/2" by 4 1/2" aluminum extrusion creates the main body of the skylight and covers the back and bottom of the assembly. The inside portion on both sides of the extrusion is closed with the closure plate. The top portion of the assembly is covered with 5" wide top plate. Two driving options are available to move the Roller Shade back and forth. The motorized option uses AC motors while the manual option uses heavy duty crank mechanism with a 7:1 turning ratio and a detachable arm. Both options come with two-piece 2 1/2" by 1" side channels on both ends.

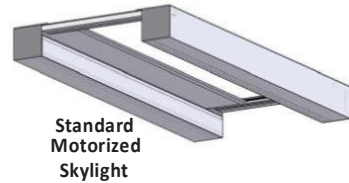

Motorized Standard Skylight:

A tubular AC motor is attached with motor brackets to the back wall of an "L" extrusion. An aircraft cable attached to the tube is guided through pulleys into the side channels. The opposite end of the cable is attached to the shade hembar. Cables are never visible during operation. The shade material is wrapped on the tube on the opposite side of the assembly. A powerful spring assist keeps fabric in constant tension.

Roll:	Available for regular or reversed roll	
Color:	White	
Mount:	Inside	
Clutch:	Crank	
Motor:	AC	
Wires:	Right or Left	
Minimum Width:	30"	Minimum Length: 30"
Maximum Width:	60"	Maximum Length: 96"

Specifications:

Electric Motor: Tubular AC motor, lifetime lubricated, instantly reversible, thermal overload protector and electric brake.

Hardware:

- Roller tubes – 6063 T6 extruded aluminum reinforced with ribs
- Spring take up – Industrial quality 2 3/4" roller with heavy duty .090" wire spring
- Idlers – Nylon 6 body with zinc plated steel pin
- Brackets – Industrial quality zinc plated 14 gage steel
- End caps – 6063 T5 extruded aluminum .100" thick.
- Head box – 6063 T5 aluminum extrusion
- Tension wire – Type 302/304 Stainless Steel Wire, Ø.063 Braking Strength 270 lb.

Premium Skylight with Adjustable Side Channels (Patent Pending):

The shade fabric for this product is constantly tensioned from both sides along the entire distance of travel. An "L"-shaped 4 1/2" x 4 1/2" aluminum extrusion provides space for both the fabric and motor. For Skylights longer than 96", a "U"-shaped 7" x 9" extrusion is used to cover motor and fabric side of Skylight.

Roll:	Available for regular roll only	
Color:	White	
Mount:	Inside	
Motor:	AC	
Wires:	Right or Left	
Minimum Width:	30"	Minimum Length: 30"
Maximum Width:	144"	Maximum Length: 180"

If the walls are not perfectly parallel, the side channel assembly provides needed adjustability and guidance for the fabric during forward and backward movement. The stationary side channel is rigidly mounted to the wall. A second sliding channel rests on the bottom lip of the stationary channel and can be adjusted along the length with screws mounted to the top vertical wall. A vinyl extrusion is placed inside of the sliding channel, thereby securing the side edge of the fabric. Additional dampening and adjustability is provided by two bulb seals which are inserted on both sides of the vinyl guiding component. Fabric enters the side channel through a molded Nylon 6 fabric guide. A heavy-duty aluminum extrusion hembar finished with Delrin end caps ensures front tension and guidance to the fabric while traveling alongside of the channels.

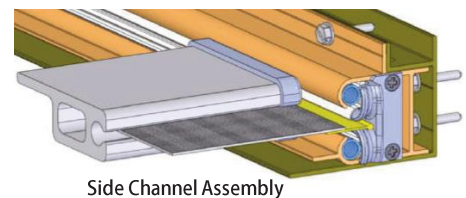
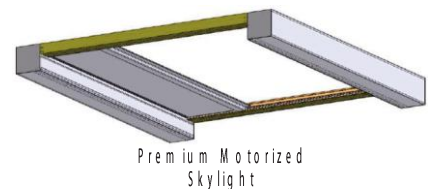

Specifications:

Electric Motor: Tubular AC motor, 3-wire, lifetime lubricated, instantly reversible, thermal overload protector and electric brake.

Hardware:

- Roller tubes – 6063 T6 extruded aluminum reinforced with ribs
- Spring take up – Industrial quality 2 3/4" roller with heavy duty .090" wire spring
- Idlers – Nylon 6 body with zinc plated steel pin
- Brackets – Industrial quality zinc plated 14 gage steel
- End caps – 6063 T5 extruded aluminum .100" thick.
- Head box – 6063 T5 aluminum extrusion
- Side channels - 6063 T5 aluminum extrusion
- Fabric retainer – Vinyl extrusion
- Fabric guide – Nylon 6 molded component
- Tension wire – Type 302/304 Stainless Steel Wire, Ø.063 Braking Strength 270lb

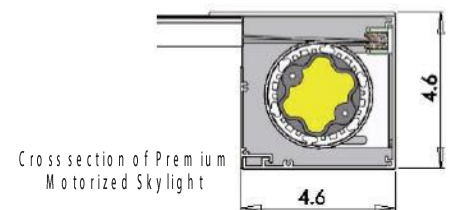

Shade Specification

- *Print Ready Files* 300¹DPI (minimum 1800 x 2400 pixel size) are preferred with art board/canvas set to the actual shade size and graphics arranged to scan and at desired placement. If files are not sent Print Ready an extra set-up surcharge will apply. Set-up is limited to sizing of logo to shade and approval process. Set-up does not include any design or selection of images, graphics or logos as these must be provided.
- Images, graphics and logos can be printed up to a maximum width of 100" with no limitation on length. Please note that printing is also limited to the chosen fabric width. Please refer to Mariak's In-Stock Roller Shade Fabric Listing & Table Index. Special order extra wide fabrics may be available as noted in the Fabric Listing; longer lead-time applies.
- All measurements (including but not limited to) graphic size, margins around graphics, dimensions, trim and ²bleed (if applicable) must be specified and should be noted on an unused layer or on the Mariak Image Printing Purchase Order Form.

If the graphic is not going to take up the entire shade space, measurements of the desired border for each side must be given.

Measurements should be given to the nearest ¼" and take from the outermost point on the sides of the graphic.

Preferred File Formats

EPS, AI, PDF, RAW or other ³vector formats or high resolution images. These file types will help to ensure the least amount of work and the greatest image quality.

Acceptable File Types

TIFF, JPEG, PSD or other standard ⁴raster formats. These file types are acceptable if the file is set to scale at the exact size the graphic is to appear on the shade. Smaller or lower resolution images will degrade and become grainy and pixilated as their proportions are stretched.

Graphic Confirmation & Approval

The Mariak Graphics Department will email a PDF file that displays all images, dimensions and shade placement and or a physical sample will be supplied (nominal fee applies) for final approval and signature. Shade will not go into production until signed proof is received. Production lead-times are longer for printed shades and are dependent upon the time required for the set-up and approval process.

Fabric Options

Translucent, blackout and fiberglass sunscreen fabrics in single color solid whites. Printing on white fabrics helps to ensure the full vibrancy of the design. Surcharge may apply for darker beige, tan or grey fabrics as an additional underlay may be required to achieve desired coloration. Dark color fabrics in tan, grey, charcoal, black or bronze are currently unavailable for printing. Please refer to the Mariak's In-Stock Roller Shade Fabric Listing & Table Index for ***Image Printable** fabric style selection. (Mariak roller shade materials only; no custom order material.)

Color Options

Mariak offers Pantone printing (CMYK/RGB) or custom color matching.

Pantone Color Name and Number to be provided on purchase order (www.pantone.com)

A printed physical fabric sample is required for precise custom color matching and a proof will be provided (nominal fee applies) for final approval.

Fonts

All typography should be converted to paths (traced). If compressed files, such as JPEG/TIFF are not sent to size some degradation of the image and loss of color value should be expected. PSDs are editable as long as fonts have not been ⁴rasterized. Any files or components within a file that require additional work, including correction of degradation of the font, will prompt additional fees.

Double Sided Printing

Double sided image printing is available on non-blackout fabrics only; with the exception of Matte Vinyl Blackout. SheerWeave Performance+ and SilverScreen fabrics cannot be printed on the back side of fabric. Graphics can be printed on 1 (one) side and a solid color on the other; full color printing can be applied to each side. Street Side or Interior Side image print to be specified on the Mariak Image Printing Purchase Order Form.

Hembar Printing

Image degradation and distortion may occur at the fabric weld if printed over the hembar.

¹DPI (Dots Per Inch)

²Bleed is used for images overlapping the border of the shade and is the area that will be trimmed off of the image

³Vector images can be a lower DPI since they will not degrade or pixilate when enlarged

⁴Rasterized images will suffer degradation and pixilation as the image is enlarged

Submitting Image Files

1. Send all files to mariak_graphics@mariak.com
 2. Larger files can be sent via a free account at [yousendit.com](https://www.yousendit.com) and email the file link to mariak_graphics@mariak.com
 3. Mail CD-ROM or Flash Drive labeled with Side Mark, Purchase Order or Mariak Sales Order Number on the label
Attn: Mariak Graphics
Mariak Window Fashions
575 West Manville Street
Rancho Dominguez, CA 90220
- Information to be provided with File Submittal
 - Indicated method of file submission on Mariak Image Printing Purchase Order Form
 - Mariak Account Number
 - Account Name
 - Contact Name & Phone Number
 - Side Mark, Purchase Order or Mariak Sales Order Number
 - Line Item Number & Shade Measurements

Disclaimers

All image printing shall be subject to verification or appropriate copyright ownership/licensure and execution of "Mariak's Custom Printing Agreement".

Warranty

Image Printed Roller shades are backed by a 5-Year Limited Warranty and must be used for interior applications only and installed behind glass that is preferably Low-Emissivity (Low-E) rated. Gradual degradation and fading of the printed image may occur over time due to sun exposure and is considered normal and will not be covered by this warranty. Please refer to "Mariak's Image Printed Roller Shade Limited Warranty" for complete details.

Pricing

- Print Ready Set-Up Fee \$ 25.00 Net Per Shade
- Non-Print Ready Set-Up Fee \$ 50.00 Net Per Shade
- Image or Logo Tracing \$ 60.00 Net Per Image
- Image, Graphic or Logo Cost \$ 4.00 Net Per Shade Per Square Foot from outer point of image including any blank or unused space contained within the image. Base pricing includes all colors with the exception of *White*. (*Minimum charge \$ 40.00 Per Shade*)
- 50% Net Per Shade Surcharge Per Square Foot applies to *White* printing.
- Solid Color Covering Entire Shade 50% Net Per Shade Surcharge Per Square Foot of printed area.
- Landscape Image Printing Spanning Multiple Shades 50% Net Per Shade Surcharge Per Square Foot of printed area.
- \$2.00 Net Per Shade Surcharge Per Square Foot of printed area applies for additional underlay on darker beige, tan or grey fabrics to achieve desired coloration.
- Printed insert for Fabric Wrapped Fascia \$10.00 Net Per Shade (*in addition to standard Fascia Cost*)
- Sample Fee for 8-1/2" x 11" Proofs is \$ 15.00 Each

If you need assistance with pricing or would like to request a quote please contact mariak_graphics@mariak.com.

Mariak

Manual Clutch & Tube Size Matrix

		Width																					
		24	30	36	42	48	54	60	66	72	78	84	90	96	102	108	114	120	126	132	144	156	162
Length	36	1 1/4" Clutch & Tube - Available with 3" & 4" Fascia														1 3/4" Clutch & Tube - No Spring Assist Required - Available with 4" Fascia				2" Steel Tube with Platinum Series Clutch & Spring Assist. When using a spring assist a surcharge will apply. Available with 4" Fascia. Maximum Length 144"			
	42																						
	48																						
	54																						
	60																						
	66								(3" Fabric Wrapped Fascia Maximum size of 96" x 72")														
	72																						
	78	1 1/2" Clutch & Tube Available with 3" & 4" Fascia																					
	84	(Shades under 96" x 84" will fit under a 3" Round or Square Fascia; shades wider or longer than 96" x 84" require 4" Fascia.)																					
	90	1 1/2" Clutch & Tube Available with 4" Fascia																					
	96																						
	102																						
	108																						
	114																						
	120	1 3/4" Clutch & Tube - No Spring Assist Required - Available with 4" Fascia																					
	126																						
132	1 3/4" Clutch & Tube - Spring Assist Required - When using a spring assist a surcharge will apply. Available with 4" Fascia.																						
138																							
144																							
150																							
156															1-3/4" Clutch & 2" Tube - Spring Assist Required. When using a spring assist a surcharge will apply. Available with 4" Fascia.								

Mariak

Motorized Tube Size Matrix

		Width															
		48	60	72	84	96	108	120	126	132	144	156	168	180	192	204	216
Length	96	1-1/2" Motor Tube- Aluminum															
	108																
	120																
	126																
	132																
	144																
	156																
	168																
	180																
	192																
	204	2-1/2" Motor Tube - Aluminum					3" Motor Tube - Aluminum						4" Motor Tube - Steel				
	216																
	228																
	240																
	252																
	264																
	276																
	288																
	300																
	312																
	324																
	336																
	348																
	360																

Mariak

IN-STOCK ROLLER SHADE FABRIC LISTING & PAGE NUMBER INDEX

FABRIC NAME	STOCK WIDTH	SPECIAL ORDER WIDTH	RAILROAD	FLAME RETARDANT	GREENGUARD CERTIFIED	*IMAGE PRINTABLE	*DOUBLE SIDED IMAGE PRINTING	PRICE TABLE PAGE NUMBER
Belize	106"	N/A	NO	NO	NO	NO	NO	39
Bordeaux	78"	N/A	NO	NO	NO	NO	NO	37
Chanel (PVC Free)	94"	N/A	NO	NO	NO	NO	NO	33
Clinique Blackout (Sanitized)	114"	N/A	YES	YES	YES	NO	NO	43
ColorVision 5%	98"	N/A	YES	YES	YES	NO	NO	41
Cortina (PVC Free) DISCONTINUED	118"	N/A	NO	NO	YES	NO	NO	37
Cross Hatch (PVC Free)	79"	N/A	NO	NO	NO	NO	NO	42
Deco Screen 5%	98"	N/A	NO	YES	YES	YES	YES	37
Dublin	98"	N/A	NO	NO	NO	NO	NO	42
Econo Screen 1%	98" or 118"	N/A	YES	YES	YES	YES	YES	35
Econo Screen 3%	98" or 118"	N/A	YES	YES	YES	YES	YES	29
Econo Screen 5%	98" or 118"	N/A	YES	YES	YES	YES	YES	27
Edessa Twilight Blackout (PVC Free)	118"	N/A	NO	YES	YES	YES	YES	39
E-Screen 7501 1%	98"	122"	YES	YES	YES	YES	YES	41
E-Screen 7503 3%	98"	122"	YES	YES	YES	YES	YES	39
E-Screen 7505 5%	98"	122"	YES	YES	YES	YES	YES	32
E-Screen 7510 10%	98"	122"	YES	YES	YES	YES	YES	32
Flocke Blackout (Lead & PVC Free)	78"	N/A	YES	YES	NO	YES	YES	47
Florence (PVC Free)	72"	N/A	NO	NO	NO	NO	NO	42
Genoa (PVC Free)	108"	N/A	NO	NO	NO	NO	NO	35
Jerusalem (PVC Free)	72"	N/A	NO	NO	NO	NO	NO	42
Matte Vinyl Blackout	72"	N/A	YES	YES	NO	YES	YES	28
Milan	72"	N/A	NO	NO	NO	NO	NO	34
Montpellier (PVC Free)	110"	N/A	NO	NO	NO	NO	NO	37
M-Screen 8503 3% Classic Colors	98"	N/A	NO	YES	YES	YES	YES	37
M-Screen 8503 3% Essence Colors	98"	N/A	NO	YES	YES	YES	YES	37
M-Screen 8505 5% Classic Colors	98"	N/A	NO	YES	YES	YES	YES	32
M-Screen 8505 5% Essence Colors	98"	N/A	NO	YES	YES	YES	YES	32
Munich Blackout (PVC Free)	94"	N/A	NO	NO	NO	NO	NO	37
Naples	106"	N/A	NO	NO	NO	NO	NO	39
Naturale (PVC Free, Recycled Materials & 100% Recyclable)	106"	N/A	NO	NO	NO	NO	NO	39
Net Series Alkenz 4000 5%	98"	118"	YES	YES	YES	YES	YES	32
Net Series Alkenz 4100 10%	98"	118"	YES	YES	YES	YES	YES	32
Net Series Alkenz 4300 3%	98"	118"	YES	YES	YES	YES	YES	32
Noblette	110"	N/A	NO	NO	NO	NO	NO	42
Palermo Blackout	110"	N/A	YES	YES	YES	NO	NO	41
Princess (PVC Free)	79"	N/A	NO	NO	NO	NO	NO	41
Salon (PVC Free)	79"	N/A	NO	NO	NO	NO	NO	42
SheerWeave 2000 5% (Lead Free)	96"	126"	YES	YES	YES	YES	YES	32
SheerWeave 2100 10% (Lead Free)	96"	126"	YES	YES	YES	YES	YES	32
SheerWeave 2360 10% (Lead Free)	98"	N/A	YES	YES	YES	YES	YES	32
SheerWeave 2390 5% (Lead Free)	98"	126"	YES	YES	YES	YES	YES	32
SheerWeave 2410 3% (Lead Free)	98"	126"	YES	YES	YES	YES	YES	36
SheerWeave 2500 1% (Lead Free)	98"	126"	YES	YES	YES	YES	YES	39
SheerWeave 2701 1% (Lead Free)	98"	N/A	YES	YES	YES	YES	YES	39
SheerWeave 2703 3% (Lead Free)	98"	N/A	YES	YES	YES	YES	YES	36

Mariak

IN-STOCK ROLLER SHADE FABRIC LISTING & PAGE NUMBER INDEX (Continued)

FABRIC NAME	STOCK WIDTH	SPECIAL ORDER WIDTH	RAILROAD	FLAME RETARDANT	GREENGUARD CERTIFIED	*IMAGE PRINTABLE	*DOUBLE SIDED IMAGE PRINTING	PRICE TABLE PAGE NUMBER
SheerWeave 2705 5% (Lead Free)	98"	N/A	YES	YES	YES	YES	YES	32
SheerWeave 2710 10% (Lead Free)	98"	N/A	YES	YES	YES	YES	YES	32
SheerWeave 3000 14% (Lead Free)	96"	N/A	NO	NO	YES	NO	NO	30
SheerWeave 4000 5% (Lead Free)	98"	N/A	YES	YES	YES	YES	YES	32
SheerWeave 4100 10% (Lead Free)	98"	N/A	YES	YES	YES	YES	YES	32
SheerWeave 4400 3% (Lead Free)	98"	N/A	YES	YES	YES	YES	YES	36
SheerWeave 4500 5% (Lead Free)	98"	N/A	YES	YES	YES	YES	YES	32
SheerWeave 4600 3% (Lead Free)	98"	N/A	YES	YES	YES	YES	YES	36
SheerWeave 4800 1% (Lead Free)	96"	N/A	YES	YES	YES	YES	YES	39
SheerWeave 5000 (Lead Free)	98"	N/A	NO	YES	YES	NO	NO	40
SheerWeave 7000 Blackout (Lead & PVC Free)	94"	N/A	NO	YES	YES	NO	NO	43
SheerWeave 7100 Blackout (Lead Free)	96"	N/A	NO	YES	YES	YES	NO	41
SheerWeave 7500 Blackout (Lead & PVC Free)	118"	N/A	NO	YES	YES	YES	NO	35
SheerWeave Infinity-2 3% (Lead & PVC Free)	98"	N/A	YES	YES	YES	NO	NO	45
SheerWeave InfiNitY-2 5% (Lead & PVC Free)	98"	N/A	YES	YES	YES	NO	NO	44
SheerWeave Performance+ 2410 3% (Energy Saving & Lead Free)	96"	N/A	YES	YES	YES	YES	NO	48
SheerWeave Performance+ 2390 5% (Energy Saving & Lead Free)	96"	N/A	YES	YES	YES	YES	NO	47
Siena 7% (Lead & PVC Free) DISCONTINUED	118"	N/A	YES	NO	YES	NO	NO	36
SilverScreen 4% (Energy Saving, Formaldehyde Free & Recyclable)	94"	N/A	NO	YES	YES	YES	NO	43
S-Screen 4% Origins & Elements Colors (Lead Free)	98"	122"	NO	YES	YES	NO	NO	42
Sunshadow Alkenz 4700Q 1% DISCONTINUED	98"	118"	YES	YES	YES	NO	NO	41
Sunshadow Alkenz CA 3000 3%	98"	118"	YES	YES	YES	YES	NO	41
Sunshadow Alkenz 4700P 1%	98"	118"	YES	YES	YES	NO	NO	39
Tapestry (PVC Free)	79"	N/A	NO	NO	NO	NO	NO	42
Tradewinds (PVC Free)	109"	N/A	NO	NO	NO	NO	NO	42
T-Screen 3% (Lead, Mercury & Bromine Free)	98"	N/A	NO	YES	YES	NO	NO	33
Ultimate Achievement Metalized Fabric (PVC Free)	94"	N/A	YES	YES	YES	YES	NO	43
Vela 3% (Lead, Mercury & PVC Free) DISCONTINUED	118"	N/A	NO	YES	YES	YES	YES	38
Vizela 1% (Lead & PVC Free)	78"	N/A	YES	YES	YES	NO	NO	46
Whitney Light Filtering	78"	N/A	YES	NO	NO	YES	YES	28
Whitney Room Darkening	78"	N/A	YES	NO	NO	NO	NO	31
Woodland (PVC Free)	72"	N/A	NO	NO	NO	NO	NO	34
Zurich Blackout	110"	N/A	NO	YES	NO	NO	NO	37
Zute (PVC Free)	72"	N/A	NO	NO	NO	NO	NO	34

* Fabric color restrictions apply. Please refer to the Mariak Image Printing Specification or complete details.

Certain fabrics and colors are available in special order wider widths and must be indicated at the time of ordering. **Mariak will not assume the responsibility for selecting special order fabric widths.** Wide width material is in high demand and takes time to source as a result of vendor production constraints. Wider width fabrics will be treated as special order only and are subject to availability. Upon request additional fabric selections and colors from Alkenz, Mermet & Phifer may be ordered. All special order fabrics must be **contract quoted and pricing is subject to change. Please consult Mariak Contract Sales for more details.**

Please be sure to indicate **full fabric name and color name/number** when submitting orders.

All prices are in U.S. Dollars and do not include freight, duties or taxes for shipments to Alaska, Hawaii or Canada. GST and VAT are not included. Other restrictions and surcharges may apply. See Freight policy for complete details.

Manufacturing specifications, options, surcharges and pricing are subject to change without notice.

Visit www.mariak.com for the most recent downloads.

Sun Control Roller Shades

EconoScreen 5% **5% Open** **98" or 118" Wide Fabric** **Polyester / PVC**

Length	Width													Side Channels
	24	36	48	60	72	84	96	108	116	120	132	144	156	
36	87	109	134	153	197	228	240	306	533	533	580	631	858	70
48	94	119	146	171	219	253	267	421	535	535	585	634	863	93
60	104	134	162	190	238	278	325	422	538	538	587	637	867	116
72	112	144	173	206	259	305	353	425	540	540	590	639	869	139
84	118	154	191	225	279	330	376	444	683	683	749	811	1065	162
96	145	185	226	265	305	359	407	631	689	689	758	820	1078	185
108	153	197	240	283	325	384	432	633	690	690	761	823	1081	208
116	171	213	255	300	347	411	458	635	694	694	766	830	1088	231
120	171	213	255	300	347	411	458	635	694	694	766	830	1088	231
132	199	249	295	347	396	468	484	750	821	821	907	983	1262	254
144	208	258	309	363	419	494	512	752	829	829	912	987	1267	277
156	238	300	363	430	496	589	614	761	839	839	1026	1111	1286	300

EconoScreen - Shades under the dashed line will be railroaded and have a visible seam

Fascia & Headbox Accessories

	Width												
Additional Options:	24	36	48	60	72	84	96	108	116	120	132	144	156
3" & 4" Square Aluminum	45	55	65	75	85	95	105	115	125	125	135	145	155
3" & 4" Round Aluminum	45	55	65	75	85	95	105	115	125	125	135	145	155
3" & 4" Fabric Wrapped	89	110	131	152	173	194	215	236	257	257	278	299	320
Shade Pocket (No Lip)	132	169	206	243	280	319	355	391	428	428	465	502	539
Shade Pocket with Lip	132	169	206	243	280	319	355	391	428	428	465	502	539
Dual Shade Pocket (No Lip)	210	289	368	447	526	605	684	763	842	842	921	1000	1079
Closure Plate for Pocket	17	24	31	38	45	50	58	66	73	73	80	87	94
Hanger with Closure Plate	21	33	45	57	69	81	93	105	117	117	129	141	153
Inserted Fabric Valance	24	30	36	42	48	54	60	66	72	72	78	84	90
Ceiling "L" Fascia	51	70	89	108	127	146	165	184	203	203	222	241	260
Sill Channel	24	35	46	57	68	79	90	101	112	112	123	134	145
Cassette Commercial	100	140	180	220	260	300	340	N/A	N/A	N/A	N/A	N/A	N/A
Cassette Retail	63	82	101	120	139	158	177	N/A	N/A	N/A	N/A	N/A	N/A

Roller Shade Surcharge Options	
Stainless Steel Chain	\$12.00
White or Black Steel Chain	\$24.00
Platinum Clutch & Stainless Steel Chain	\$15.00 NET
Platinum Clutch & Painted Steel Chain	\$27.00 NET
Rollease R-Series Clutch R8/R16/R24	\$0.00
External Aluminum Hembar	\$10.00
Wrapped Hembar	\$15.00
Spring Assisted Clutch	\$125.00
*Exterior Guide Cable System	\$200.00
Bottom-Up Shade w/Clutch	\$275.00
Multiple Band Motorized Shades	
1. Price each band separately and add together	
2. Price each coupler surcharge and add together	
3. Add shade band and coupler prices together	
Straight Line Coupler	\$100.00
90° Corner Coupler	\$200.00

* Fascia Required for an additional charge.

Important Items To Note:

Screen fabrics will be fabricated vertically or horizontally (railroaded) at the factory's discretion or as noted on the price table above. Any shades wider and longer than the fabric's width will have one or more visible seams (splices).
The maximum warranted size of a clutch operated shade is 126" x 144".
Large Clutch shades may require a spring assisted lifting mechanism. Please refer to the manual clutch & tube matrix to determine if a spring assist is required.
Side channel surcharge includes left & right channels. Seal brushes available upon request.
Prices for valances, boxes, and pockets include all brackets and end caps.
Reverse roll option is not available for square, round, or wrapped fabric fascias.
The size of a shade will determine the size of the tube used; upgrades to larger tubes will be available upon request. Please refer to the manual/motorized clutch & tube matrix for specifics.
Shades exceeding a 3-to-1 ratio may have problems tracking. In other words, shades with a height dimension that is more than 3 times the width measurement may be susceptible to telescoping.
ALL MEASUREMENTS ARE BRACKET-TO-BRACKET

Shades up to 102" in width shipped via FedEx: \$4.00 / unit Net Freight Charge
Shades 102-118" to 125" in width shipped via FedEx: \$ 75.00 / unit Net Freight Charge
Shades 125 1/8" or greater in width shipped via Common Carrier: \$ 150.00 per shipment
Manufacturing specifications, options, surcharges and pricing are subject to change without notice.
Visit www.mariak.com for the most recent downloads.
All prices are in U.S. Dollars and do not include freight, duties or taxes for shipments to Alaska, Hawaii or Canada. GST and VAT are not included. Other restrictions and surcharges may apply. See Freight Policy for complete details.

Sun Control Roller Shades

Matte Vinyl Blackout	0% Open	72" Wide Fabric	Fiberglass / PVC Laminated
Whitney	Light Filtering	78" Wide Fabric	Polyester

Length	Width														Side Channels
	24	36	48	60	70	72	76	84	96	108	120	132	144	156	
36	88	111	137	159	204	204	234	234	248	315	550	598	652	888	70
48	97	122	149	175	225	225	260	260	274	434	552	605	656	894	93
60	106	137	166	195	245	245	288	288	334	436	556	607	658	897	116
70	114	147	178	212	268	268	312	312	363	437	558	611	660	899	139
72	114	147	178	212	268	268	312	312	363	437	558	611	660	899	139
76	121	160	196	231	289	289	341	341	388	458	706	775	838	1102	162
84	121	160	196	231	289	289	341	341	388	458	706	775	838	1102	162
96	148	191	232	273	312	312	371	371	420	652	712	785	847	1114	185
108	159	203	248	293	334	334	397	397	446	654	713	788	852	1120	208
120	175	219	264	310	357	357	424	424	474	656	719	793	857	1125	231
132	206	255	304	357	410	410	483	483	500	776	850	939	1017	1307	254
144	214	267	319	375	432	432	511	511	528	777	856	943	1021	1311	277
156	246	310	375	444	513	513	609	609	634	788	866	1061	1150	1330	300

Matte Vinyl - Shades under the double line will be railroaded and have a visible seam
Whitney - Shades under the dashed line will be railroaded and have a visible seam

Fascia & Headbox Accessories

	Width													
Additional Options:	24	36	48	60	70	72	76	84	96	108	120	132	144	156
3" & 4" Square Aluminum	45	55	65	75	85	85	95	95	105	115	125	135	145	155
3" & 4" Round Aluminum	45	55	65	75	85	85	95	95	105	115	125	135	145	155
3" & 4" Fabric Wrapped	89	110	131	152	173	173	194	194	215	236	257	278	299	320
Shade Pocket (No Lip)	132	169	206	243	280	280	319	319	355	391	428	465	502	539
Shade Pocket with Lip	132	169	206	243	280	280	319	319	355	391	428	465	502	539
Dual Shade Pocket (No Lip)	210	289	368	447	526	526	605	605	684	763	842	921	1000	1079
Closure Plate for Pocket	17	24	31	38	45	45	50	50	58	66	73	80	87	94
Hanger with Closure Plate	21	33	45	57	69	69	81	81	93	105	117	129	141	153
Inserted Fabric Valance	24	30	36	42	48	48	54	54	60	66	72	78	84	90
Ceiling "L" Fascia	51	70	89	108	127	127	146	146	165	184	203	222	241	260
Sill Channel	24	35	46	57	68	68	79	79	90	101	112	123	134	145
Cassette Commercial	100	140	180	220	260	260	300	300	340	N/A	N/A	N/A	N/A	N/A
Cassette Retail	63	82	101	120	139	139	158	158	177	N/A	N/A	N/A	N/A	N/A

Roller Shade Surcharge Options	
Stainless Steel Chain	\$12.00
White or Black Steel Chain	\$24.00
Platinum Clutch & Stainless Steel Chain	\$15.00 NET
Platinum Clutch & Painted Steel Chain	\$27.00 NET
Rollease R-Series Clutch R8/R16/R24	\$0.00
External Aluminum Hembar	\$10.00
Wrapped Hembar	\$15.00
Spring Assisted Clutch	\$125.00
*Exterior Guide Cable System	\$200.00
Bottom-Up Shade w/Clutch	\$275.00
Multiple Band Motorized Shades	
1. Price each band separately and add together	
2. Price each coupler surcharge and add together	
3. Add shade band and coupler prices together	
Straight Line Coupler	\$100.00
90° Corner Coupler	\$200.00

* Fascia Required for an additional charge.

Important Items To Note:

Screen fabrics will be fabricated vertically or horizontally (railroaded) at the factory's discretion or as noted on the price table above. Any shades wider and longer than the fabric's width will have one or more visible seams (splices).
The maximum warranted size of a clutch operated shade is 126" x 144".
Large Clutch shades may require a spring assisted lifting mechanism. Please refer to the manual clutch & tube matrix to determine if a spring assist is required.
Side channel surcharge includes left & right channels. Seal brushes available upon request.
Prices for valances, boxes, and pockets include all brackets and end caps.
Reverse roll option is not available for square, round, or wrapped fabric fascias.
The size of a shade will determine the size of the tube used; upgrades to larger tubes will be available upon request. Please refer to the manual/motorized clutch & tube matrix for specifics.
Shades exceeding a 3-to-1 ratio may have problems tracking. In other words, shades with a height dimension that is more than 3 times the width measurement may be susceptible to telescoping.
ALL MEASUREMENTS ARE BRACKET-TO-BRACKET

Shades up to 102" in width shipped via FedEx: \$4.00 / unit Net Freight Charge
Shades 102-1/8" to 125" in width shipped via FedEx: \$ 75.00 / unit Net Freight Charge
Shades 125 1/8" or greater in width shipped via Common Carrier: \$ 150.00 per shipment
Manufacturing specifications, options, surcharges and pricing are subject to change without notice.
Visit www.mariak.com for the most recent downloads.
All prices are in U.S. Dollars and do not include freight, duties or taxes for shipments to Alaska, Hawaii or Canada. GST and VAT are not included. Other restrictions and surcharges may apply. See Freight Policy for complete details.

Sun Control Roller Shades

EconoScreen 3% 3% Open 98" or 118" Wide Fabric Polyester / PVC

		Width												Side Channels	
		24	36	48	60	72	84	96	108	116	120	132	144	156	
Length	36	96	122	149	172	220	256	268	343	596	596	649	707	961	70
	48	106	135	164	192	246	283	299	472	600	600	656	710	1027	93
	60	116	149	181	212	267	312	364	473	603	603	658	713	971	116
	72	124	161	195	230	291	342	395	477	605	605	661	717	974	139
	84	134	173	213	253	315	371	422	497	764	764	841	907	1194	162
	96	163	208	254	297	342	402	456	707	773	773	850	918	1208	185
	108	172	220	268	318	363	431	485	709	774	774	852	922	1212	208
	116	192	240	285	335	388	460	513	711	778	778	860	930	1218	231
	120	192	240	285	335	388	460	513	711	778	778	860	930	1218	231
	132	222	278	329	388	444	525	542	841	921	921	1017	1101	1414	254
	144	233	290	347	408	468	554	574	843	929	929	1022	1106	1420	277
	156	267	335	408	482	555	659	688	852	940	940	1150	1244	1441	300

EconoScreen - Shades under the dashed line will be railroaded and have a visible seam

Fascia & Headbox Accessories

	Width												
	24	36	48	60	72	84	96	108	116	120	132	144	156
Additional Options:													
3" & 4" Square Aluminum	45	55	65	75	85	95	105	115	125	125	135	145	155
3" & 4" Round Aluminum	45	55	65	75	85	95	105	115	125	125	135	145	155
3" & 4" Fabric Wrapped	89	110	131	152	173	194	215	236	257	257	278	299	320
Shade Pocket (No Lip)	132	169	206	243	280	319	355	391	428	428	465	502	539
Shade Pocket with Lip	132	169	206	243	280	319	355	391	428	428	465	502	539
Dual Shade Pocket (No Lip)	210	289	368	447	526	605	684	763	842	842	921	1000	1079
Closure Plate for Pocket	17	24	31	38	45	50	58	66	73	73	80	87	94
Hanger with Closure Plate	21	33	45	57	69	81	93	105	117	117	129	141	153
Inserted Fabric Valance	24	30	36	42	48	54	60	66	72	72	78	84	90
Ceiling "L" Fascia	51	70	89	108	127	146	165	184	203	203	222	241	260
Sill Channel	24	35	46	57	68	79	90	101	112	112	123	134	145
Cassette Commercial	100	140	180	220	260	300	340	N/A	N/A	N/A	N/A	N/A	N/A
Cassette Retail	63	82	101	120	139	158	177	N/A	N/A	N/A	N/A	N/A	N/A

Roller Shade Surcharge Options	
Stainless Steel Chain	\$12.00
White or Black Steel Chain	\$24.00
Platinum Clutch & Stainless Steel Chain	\$15.00 NET
Platinum Clutch & Painted Steel Chain	\$27.00 NET
Rollease R-Series Clutch R8/R16/R24	\$0.00
External Aluminum Hembar	\$10.00
Wrapped Hembar	\$15.00
Spring Assisted Clutch	\$125.00
*Exterior Guide Cable System	\$200.00
Bottom-Up Shade w/Clutch	\$275.00
Multiple Band Motorized Shades	
1. Price each band separately and add together	
2. Price each coupler surcharge and add together	
3. Add shade band and coupler prices together	
Straight Line Coupler	\$100.00
90° Corner Coupler	\$200.00

* Fascia Required for an additional charge.

Important Items To Note:

Screen fabrics will be fabricated vertically or horizontally (railroaded) at the factory's discretion or as noted on the price table above. Any shades wider and longer than the fabric's width will have one or more visible seams (splices).
The maximum warranted size of a clutch operated shade is 126" x 144".
Large Clutch shades may require a spring assisted lifting mechanism. Please refer to the manual clutch & tube matrix to determine if a spring assist is required.
Side channel surcharge includes left & right channels. Seal brushes available upon request.
Prices for valances, boxes, and pockets include all brackets and end caps.
Reverse roll option is not available for square, round, or wrapped fabric fascias.
The size of a shade will determine the size of the tube used; upgrades to larger tubes will be available upon request. Please refer to the manual/motorized clutch & tube matrix for specifics.
Shades exceeding a 3-to-1 ratio may have problems tracking. In other words, shades with a height dimension that is more than 3 times the width measurement may be susceptible to telescoping.
ALL MEASUREMENTS ARE BRACKET-TO-BRACKET

Shades up to 102" in width shipped via FedEx: \$4.00 / unit Net Freight Charge
Shades 102-125" in width shipped via FedEx: \$75.00 / unit Net Freight Charge
Shades 125 1/8" or greater in width shipped via Common Carrier: \$150.00 per shipment
Manufacturing specifications, options, surcharges and pricing are subject to change without notice.
Visit www.mariak.com for the most recent downloads.
All prices are in U.S. Dollars and do not include freight, duties or taxes for shipments to Alaska, Hawaii or Canada. GST and VAT are not included. Other restrictions and surcharges may apply. See Freight Policy for complete details.

Sun Control Roller Shades

SheerWeave 3000 (Lead Free/No Railroading) 14% Open 96" Wide Fabric Fiberglass/PVC

Length	Width													Side Channels		
	24	36	48	60	72	84	94	96	108	120	132	144	156			
36	101	127	156	182	234	272	285	Grid does not apply beyond this point							70	
48	111	142	172	204	260	302	318									93
60	122	156	193	225	282	332	387									116
72	130	169	207	245	309	362	420									139
84	141	184	226	267	333	394	450									162
94	171	220	268	316	362	429	484									185
96	171	220	268	316	362	429	484									185
108	182	234	285	337	386	459	517									208
120	204	253	304	359	413	489	546									231
132	237	296	351	413	474	560	578									254
144	248	308	369	433	499	591	611									277
156	283	359	433	513	592	704	733									300

SheerWeave 3000 - Maximum Width Single Shade 94"

Fascia & Headbox Accessories

	Width												
	24	36	48	60	72	84	94	96	108	120	132	144	156
Additional Options:													
3" & 4" Square Aluminum	45	55	65	75	85	95	105	105	115	125	135	145	155
3" & 4" Round Aluminum	45	55	65	75	85	95	105	105	115	125	135	145	155
3" & 4" Fabric Wrapped	89	110	131	152	173	194	215	215	236	257	278	299	320
Shade Pocket (No Lip)	132	169	206	243	280	319	355	355	391	428	465	502	539
Shade Pocket with Lip	132	169	206	243	280	319	355	355	391	428	465	502	539
Dual Shade Pocket (No Lip)	210	289	368	447	526	605	684	684	763	842	921	1000	1079
Closure Plate for Pocket	17	24	31	38	45	50	58	58	66	73	80	87	94
Hanger with Closure Plate	21	33	45	57	69	81	93	93	105	117	129	141	153
Inserted Fabric Valance	24	30	36	42	48	54	60	60	66	72	78	84	90
Ceiling "L" Fascia	51	70	89	108	127	146	165	165	184	203	222	241	260
Sill Channel	24	35	46	57	68	79	90	90	101	112	123	134	145
Cassette Commercial	100	140	180	220	260	300	340	340	N/A	N/A	N/A	N/A	N/A
Cassette Retail	63	82	101	120	139	158	177	177	N/A	N/A	N/A	N/A	N/A

Roller Shade Surcharge Options	
Stainless Steel Chain	\$12.00
White or Black Steel Chain	\$24.00
Platinum Clutch & Stainless Steel Chain	\$15.00 NET
Platinum Clutch & Painted Steel Chain	\$27.00 NET
Rollease R-Series Clutch R8/R16/R24	\$0.00
External Aluminum Hembar	\$10.00
Wrapped Hembar	\$15.00
Spring Assisted Clutch	\$125.00
*Exterior Guide Cable System	\$200.00
Bottom-Up Shade w/Clutch	\$275.00
Multiple Band Motorized Shades	
1. Price each band separately and add together	
2. Price each coupler surcharge and add together	
3. Add shade band and coupler prices together	
Straight Line Coupler	\$100.00
90° Corner Coupler	\$200.00

* Fascia Required for an additional charge.

Important Items To Note:

Screen fabrics will be fabricated vertically or horizontally (railroaded) at the factory's discretion or as noted on the price table above. Any shades wider and longer than the fabric's width will have one or more visible seams (splices).

The maximum warranted size of a clutch operated shade is 126" x 144".

Large Clutch shades may require a spring assisted lifting mechanism. Please refer to the manual clutch & tube matrix to determine if a spring assist is required.

Side channel surcharge includes left & right channels. Seal brushes available upon request.

Prices for valances, boxes, and pockets include all brackets and end caps.

Reverse roll option is not available for square, round, or wrapped fabric fascias.

The size of a shade will determine the size of the tube used; upgrades to larger tubes will be available upon request. Please refer to the manual/motorized clutch & tube matrix for specifics.

Shades exceeding a 3-to-1 ratio may have problems tracking. In other words, shades with a height dimension that is more than 3 times the width measurement may be susceptible to telescoping.

ALL MEASUREMENTS ARE BRACKET-TO-BRACKET

Shades up to 102" in width shipped via FedEx: \$4.00 / unit Net Freight Charge
Shades 102-8" to 125" in width shipped via FedEx: \$ 75.00 / unit Net Freight Charge
Shades 125 1/8" or greater in width shipped via Common Carrier: \$ 150.00 per shipment
Manufacturing specifications, options, surcharges and pricing are subject to change without notice.
Visit www.mariak.com for the most recent downloads.
All prices are in U.S. Dollars and do not include freight, duties or taxes for shipments to Alaska, Hawaii or Canada. GST and VAT are not included. Other restrictions and surcharges may apply. See Freight Policy for complete details.

Sun Control Roller Shades

Whitney		0%Open												78" Wide Fabric												Polyester
Length	Width	Width												Side Channels												
		24	36	48	60	72	76	84	96	108	120	132	144		156											
36		106	134	164	191	246	282	282	298	378	660	719	783	1065	70											
48		117	148	179	212	271	314	314	329	522	664	727	788	1073	93											
60		126	164	200	233	294	347	347	403	525	668	730	791	1077	116											
72		138	176	215	254	322	376	376	436	526	669	734	793	1079	139											
76		146	192	234	278	348	410	410	467	550	848	931	1005	1322	162											
84		146	192	234	278	348	410	410	467	550	848	931	1005	1322	162											
96		177	228	279	328	375	445	445	505	783	855	942	1017	1338	185											
108		191	245	298	352	403	477	477	536	786	856	946	1023	1344	208											
120		212	264	317	373	429	509	509	569	788	863	952	1029	1350	231											
132		248	307	366	429	492	581	581	601	932	1021	1126	1220	1569	254											
144		257	321	383	450	519	614	614	634	933	1028	1131	1226	1574	277											
156		296	373	450	533	616	732	732	761	946	1040	1274	1380	1596	300											

Whitney - Shades under the dashed line will be railroaded and have a visible seam

Fascia & Headbox Accessories

	Width													
	24	36	48	60	72	76	84	96	108	120	132	144	156	
Additional Options:														
3" & 4" Square Aluminum	45	55	65	75	85	95	95	105	115	125	135	145	155	
3" & 4" Round Aluminum	45	55	65	75	85	95	95	105	115	125	135	145	155	
3" & 4" Fabric Wrapped	89	110	131	152	173	194	194	215	236	257	278	299	320	
Shade Pocket (No Lip)	132	169	206	243	280	319	319	355	391	428	465	502	539	
Shade Pocket with Lip	132	169	206	243	280	319	319	355	391	428	465	502	539	
Dual Shade Pocket (No Lip)	210	289	368	447	526	605	605	684	763	842	921	1000	1079	
Closure Plate for Pocket	17	24	31	38	45	50	50	58	66	73	80	87	94	
Hanger with Closure Plate	21	33	45	57	69	81	81	93	105	117	129	141	153	
Inserted Fabric Valance	24	30	36	42	48	54	54	60	66	72	78	84	90	
Ceiling "L" Fascia	51	70	89	108	127	146	146	165	184	203	222	241	260	
Sill Channel	24	35	46	57	68	79	79	90	101	112	123	134	145	
Cassette Commercial	100	140	180	220	260	300	300	340	N/A	N/A	N/A	N/A	N/A	
Cassette Retail	63	82	101	120	139	158	158	177	N/A	N/A	N/A	N/A	N/A	

Roller Shade Surcharge Options	
Stainless Steel Chain	\$12.00
White or Black Steel Chain	\$24.00
Platinum Clutch & Stainless Steel Chain	\$15.00 NET
Platinum Clutch & Painted Steel Chain	\$27.00 NET
Rollease R-Series Clutch R8/R16/R24	\$0.00
External Aluminum Hembar	#####
Wrapped Hembar	#####
Spring Assisted Clutch	\$125.00
*Exterior Guide Cable System	\$200.00
Bottom-Up Shade w/Clutch	\$275.00
Multiple Band Motorized Shades	
1. Price each band separately and add together	
2. Price each coupler surcharge and add together	
3. Add shade band and coupler prices together	
Straight Line Coupler	\$100.00
90° Corner Coupler	\$200.00

* Fascia Required for an additional charge.

Important Items To Note:

Screen fabrics will be fabricated vertically or horizontally (railroaded) at the factory's discretion or as noted on the price table above. Any shades wider and longer than the fabric's width will have one or more visible seams (splices).
The maximum warranted size of a clutch operated shade is 126" x 144".
Large Clutch shades may require a spring assisted lifting mechanism. Please refer to the manual clutch & tube matrix to determine if a spring assist is required.
Side channel surcharge includes left & right channels. Seal brushes available upon request.
Prices for valances, boxes, and pockets include all brackets and end caps.
Reverse roll option is not available for square, round, or wrapped fabric fascias.
The size of a shade will determine the size of the tube used; upgrades to larger tubes will be available upon request. Please refer to the manual/motorized clutch & tube matrix for specifics.
Shades exceeding a 3-to-1 ratio may have problems tracking. In other words, shades with a height dimension that is more than 3 times the width measurement may be susceptible to telescoping.
ALL MEASUREMENTS ARE BRACKET-TO-BRACKET

Shades up to 102" in width shipped via FedEx: \$4.00 / unit Net Freight Charge
Shades 102-8" to 125" in width shipped via FedEx: \$ 75.00 / unit Net Freight Charge
Shades 125 1/8" or greater in width shipped via Common Carrier: \$ 150.00 per shipment
Manufacturing specifications, options, surcharges and pricing are subject to change without notice.
Visit www.mariak.com for the most recent downloads.
All prices are in U.S. Dollars and do not include freight, duties or taxes for shipments to Alaska, Hawaii or Canada. GST and VAT are not included. Other restrictions and surcharges may apply. See Freight Policy for complete details.

Sun Control Roller Shades

<i>SheerWeave 2000-5% & SheerWeave 2100-10% (Lead Free)</i>	<i>5% & 10% Open</i>	<i>96" Wide Fabric</i>	<i>Fiberglass / PVC</i>
<i>SheerWeave 2390-5% & SheerWeave 2360-10% (Lead Free)</i>	<i>5% & 10% Open</i>	<i>98" Wide Fabric</i>	<i>Fiberglass / PVC</i>
<i>SheerWeave 2705-5% & SheerWeave 2710-10% (Lead Free)</i>	<i>5% & 10% Open</i>	<i>98" Wide Fabric</i>	<i>Fiberglass / PVC</i>
<i>SheerWeave 4000-5% & SheerWeave 4100-10% (Lead Free)</i>	<i>5% & 10% Open</i>	<i>98" Wide Fabric</i>	<i>Polyester / PVC</i>
<i>SheerWeave 4500 (Lead Free)</i>	<i>5% Open</i>	<i>98" Wide Fabric</i>	<i>Polyester / PVC</i>
<i>E-Screen 7505-5% & E-Screen 7510-10%</i>	<i>5% & 10% Open</i>	<i>98" Wide Fabric</i>	<i>Fiberglass / PVC</i>
<i>Alkenz Net Series 3% 4300, Net Series 5% 4000 & Net Series 10% 4100</i>	<i>3%, 5% & 10% Open</i>	<i>98" Wide Fabric</i>	<i>Polyester / PVC</i>
<i>M-Screen 8505 Classic or Essence Colors (No Railroadng)</i>	<i>5% Open</i>	<i>98" Wide Fabric</i>	<i>Fiberglass / PVC</i>

****Special order fabric widths must be indicated at the time of ordering and Mariak will not assume responsibility for selecting special order fabric widths****

Length	Width													Side Channels
	24	36	48	60	72	84	94	96	108	120	132	144	156	
36	110	141	171	199	257	297	311	311	396	695	756	821	1122	70
48	122	154	189	221	283	328	347	347	548	697	763	828	1128	93
60	134	171	210	246	308	364	423	423	550	702	766	831	1131	116
72	144	185	227	267	338	395	459	459	552	705	770	835	1134	139
84	153	200	248	293	366	430	490	490	578	891	977	1057	1391	162
94	188	241	294	344	395	468	529	529	821	900	990	1070	1409	185
96	188	241	294	344	395	468	529	529	821	900	990	1070	1409	185
108	199	256	311	369	422	501	565	565	825	902	994	1075	1414	208
120	221	276	331	392	453	534	596	596	829	906	1000	1082	1420	231
132	259	322	383	452	517	611	632	632	978	1073	1184	1284	1648	254
144	270	337	402	474	544	644	666	666	980	1080	1189	1288	1654	277
156	309	392	474	562	646	768	800	800	994	1095	1340	1451	1680	300

SheerWeave 2000 - Shades under the double line will railroaded and have a visible seam

SW2390, SW2705, SW4000, SW4500, E-Screen & Net Series - Shades under the dashed dashed line will be railroaded and have a visible seam

M-Screen 8505 - Maximum Width Single Shade 96"

Fascia & Headbox Accessories

	Width												
	24	36	48	60	72	84	94	96	108	120	132	144	156
Additional Options:													
3" & 4" Square Aluminum	45	55	65	75	85	95	105	105	115	125	135	145	155
3" & 4" Round Aluminum	45	55	65	75	85	95	105	105	115	125	135	145	155
3" & 4" Fabric Wrapped	89	110	131	152	173	194	215	215	236	257	278	299	320
Shade Pocket (No Lip)	132	169	206	243	280	319	355	355	391	428	465	502	539
Shade Pocket with Lip	132	169	206	243	280	319	355	355	391	428	465	502	539
Dual Shade Pocket (No Lip)	210	289	368	447	526	605	684	684	763	842	921	1000	1079
Closure Plate for Pocket	17	24	31	38	45	50	58	58	66	73	80	87	94
Hanger with Closure Plate	21	33	45	57	69	81	93	93	105	117	129	141	153
Inserted Fabric Valance	24	30	36	42	48	54	60	60	66	72	78	84	90
Ceiling "L" Fascia	51	70	89	108	127	146	165	165	184	203	222	241	260
Sill Channel	24	35	46	57	68	79	90	90	101	112	123	134	145
Cassette Commercial	100	140	180	220	260	300	340	340	N/A	N/A	N/A	N/A	N/A
Cassette Retail	63	82	101	120	139	158	177	177	N/A	N/A	N/A	N/A	N/A

Roller Shade Surcharge Options	
Stainless Steel Chain	\$12.00
White or Black Steel Chain	\$24.00
Platinum Clutch w/Steel Chain	\$10.00 NET
Rollease R-Series Clutch R8/R16/R24	\$0.00
External Aluminum Hembar	\$10.00
Wrapped Hembar	\$15.00
Spring Assisted Clutch	\$125.00
*Exterior Guide Cable System	\$200.00
Bottom-Up Shade w/Clutch	\$275.00
Multiple Band Motorized Shades	
1. Price each band separately and add together	
2. Price each coupler surcharge and add together	
3. Add shade band and coupler prices together	
Straight Line Coupler	\$100.00
90° Corner Coupler	\$200.00

* Fascia Required for an additional charge.

Important Items To Note:

Screen fabrics will be fabricated vertically or horizontally (railroaded) at the factory's discretion or as noted on the price table above. Any shades wider and longer than the fabric's width will have one or more visible seams (splices).

The maximum warrantied size of a clutch operated shade is 126" x 144".

Large Clutch shades may require a spring assisted lifting mechanism. Please refer to the manual clutch & tube matrix to determine if a spring assist is required.

Side channel surcharge includes left & right channels. Seal brushes available upon request.

Prices for valances, boxes, and pockets include all brackets and end caps.

Reverse roll option is not available for square, round, or wrapped fabric fascias.

The size of a shade will determine the size of the tube used; upgrades to larger tubes will be available upon request. Please refer to the manual/motorized clutch & tube matrix for specifics.

Shades exceeding a 3-to-1 ratio may have problems tracking. In other words, shades with a height dimension that is more than 3 times the width measurement may be susceptible to telescoping.

ALL MEASUREMENTS ARE BRACKET-TO-BRACKET

Shades up to 102" in width shipped via FedEx: \$4.00 / unit Net Freight Charge
Shades 102-1/8" to 125" in width shipped via FedEx: \$ 75.00 / unit Net Freight Charge
Shades 125 1/8" or greater in width shipped via Common Carrier: \$ 150.00 per shipment
Manufacturing specifications, options, surcharges and pricing are subject to change without notice.
Visit www.mariak.com for the most recent downloads.
All prices are in U.S. Dollars and do not include freight, duties or taxes for shipments to Alaska, Hawaii or Canada. GST and VAT are not included. Other restrictions and surcharges may apply. See Freight Policy for complete details.

Sun Control Roller Shades

Chanel (PVC Free/No Railroading)	N/A	94" Wide Fabric	Polyester/Acrylic
T-Screen (Lead, Mercury & Bromine Free/No Railroading)	3% Open	98" Wide Fabric	Fiberglass/PVC

Length	Width										Side Channels			
	24	36	48	60	72	76	84	96	108	120		132	144	156
36	110	141	171	199	257	297	297	311	Grid does not apply beyond this point					70
48	122	154	189	221	283	328	328	347						93
60	134	171	210	246	308	364	364	423						116
72	144	185	227	267	338	395	395	459						139
76	153	200	248	293	366	430	430	490						162
84	153	200	248	293	366	430	430	490						162
96	188	241	294	344	395	468	468	529						185
108	199	256	311	369	422	501	501	565						208
120	221	276	331	392	453	534	534	596						231
132	259	322	383	452	517	611	611	632						254
144	270	337	402	474	544	644	644	666						277
156	309	392	474	562	646	768	768	800						300

Chanel - Maximum Width Single Shade 92"

T-Screen - Maximum Width Single Shade 96"

Fascia & Headbox Accessories

	Width												
	24	36	48	60	72	76	84	96	108	120	132	144	156
Additional Options:													
3" & 4" Square Aluminum	45	55	65	75	85	95	95	105	115	125	135	145	155
3" & 4" Round Aluminum	45	55	65	75	85	95	95	105	115	125	135	145	155
3" & 4" Fabric Wrapped	89	110	131	152	173	194	194	215	236	257	278	299	320
Shade Pocket (No Lip)	132	169	206	243	280	319	319	355	391	428	465	502	539
Shade Pocket with Lip	132	169	206	243	280	319	319	355	391	428	465	502	539
Dual Shade Pocket (No Lip)	210	289	368	447	526	605	605	684	763	842	921	1000	1079
Closure Plate for Pocket	17	24	31	38	45	50	50	58	66	73	80	87	94
Hanger with Closure Plate	21	33	45	57	69	81	81	93	105	117	129	141	153
Inserted Fabric Valance	24	30	36	42	48	54	54	60	66	72	78	84	90
Ceiling "L" Fascia	51	70	89	108	127	146	146	165	184	203	222	241	260
Sill Channel	24	35	46	57	68	79	79	90	101	112	123	134	145
Cassette Commercial	100	140	180	220	260	300	300	340	N/A	N/A	N/A	N/A	N/A
Cassette Retail	63	82	101	120	139	158	158	177	N/A	N/A	N/A	N/A	N/A

Roller Shade Surcharge Options	
Stainless Steel Chain	\$12.00
White or Black Steel Chain	\$24.00
Platinum Clutch w/Steel Chain	\$10.00 NET
Rollease R-Series Clutch R8/R16/R24	\$0.00
External Aluminum Hembar	\$10.00
Wrapped Hembar	\$15.00
Spring Assisted Clutch	\$125.00
*Exterior Guide Cable System	\$200.00
Bottom-Up Shade w/Clutch	\$275.00
Multiple Band Motorized Shades	
1. Price each band separately and add together	
2. Price each coupler surcharge and add together	
3. Add shade band and coupler prices together	
Straight Line Coupler	\$100.00
90° Corner Coupler	\$200.00

* Fascia Required for an additional charge.

Important Items To Note:

Screen fabrics will be fabricated vertically or horizontally (railroaded) at the factory's discretion or as noted on the price table above. Any shades wider and longer than the fabric's width will have one or more visible seams (splices).
The maximum warranted size of a clutch operated shade is 126" x 144".
Large Clutch shades may require a spring assisted lifting mechanism. Please refer to the manual clutch & tube matrix to determine if a spring assist is required.
Side channel surcharge includes left & right channels. Seal brushes available upon request.
Prices for valances, boxes, and pockets include all brackets and end caps.
Reverse roll option is not available for square, round, or wrapped fabric fascias.
The size of a shade will determine the size of the tube used; upgrades to larger tubes will be available upon request. Please refer to the manual/motorized clutch & tube matrix for
Shades exceeding a 3-to-1 ratio may have problems tracking. In other words, shades with a height dimension that is more than 3 times the width measurement may be susceptible to
ALL MEASUREMENTS ARE BRACKET-TO-BRACKET

Shades up to 102" in width shipped via FedEx: \$4.00 / unit Net Freight Charge
Shades 102-1/8" to 125" in width shipped via FedEx: \$ 75.00 / unit Net Freight Charge
Shades 125 1/8" or greater in width shipped via Common Carrier: \$ 150.00 per shipment
Manufacturing specifications, options, surcharges and pricing are subject to change without notice.
Visit www.mariak.com for the most recent downloads.
All prices are in U.S. Dollars and do not include freight, duties or taxes for shipments to Alaska, Hawaii or Canada. GST and VAT are not included. Other restrictions and surcharges may apply. See Freight Policy for complete details.

Sun Control Roller Shades

Milan (No Railroading)	72" Wide Fabric	Polyester
Woodland (No Railroading)	72" Wide Fabric	Polyester
Zute (No Railroading)	72" Wide Fabric	Polyester

Length	Width											Side Channels
	24	36	48	60	70	84	96	108	120	132	144	156
36	110	141	171	199	257	Grid does not apply beyond this point						70
48	122	154	189	221	283							93
60	134	171	210	246	308							116
70	144	185	227	267	338							139
84	153	200	248	293	366							162
96	188	241	294	344	395							185
108	199	256	311	369	422							208
120	221	276	331	392	453							231
132	259	322	383	452	517							254
144	270	337	402	474	544							277
156	309	392	474	562	646							300

Milan, Woodland & Zute - Maximum Width Single Shade 70"

Fascia & Headbox Accessories

	Width											
	24	36	48	60	70	84	96	108	120	132	144	156
Additional Options:	24	36	48	60	70	84	96	108	120	132	144	156
3" & 4" Square Aluminum	45	55	65	75	85	95	105	115	125	135	145	155
3" & 4" Round Aluminum	45	55	65	75	85	95	105	115	125	135	145	155
3" & 4" Fabric Wrapped	89	110	131	152	173	194	215	236	257	278	299	320
Shade Pocket (No Lip)	132	169	206	243	280	319	355	391	428	465	502	539
Shade Pocket with Lip	132	169	206	243	280	319	355	391	428	465	502	539
Dual Shade Pocket (No Lip)	210	289	368	447	526	605	684	763	842	921	1000	1079
Closure Plate for Pocket	17	24	31	38	45	50	58	66	73	80	87	94
Hanger with Closure Plate	21	33	45	57	69	81	93	105	117	129	141	153
Inserted Fabric Valance	24	30	36	42	48	54	60	66	72	78	84	90
Ceiling "L" Fascia	51	70	89	108	127	146	165	184	203	222	241	260
Sill Channel	24	35	46	57	68	79	90	101	112	123	134	145
Cassette Commercial	100	140	180	220	260	300	340	N/A	N/A	N/A	N/A	N/A
Cassette Retail	63	82	101	120	139	158	177	N/A	N/A	N/A	N/A	N/A

Roller Shade Surcharge Options	
Stainless Steel Chain	\$12.00
White or Black Steel Chain	\$24.00
Platinum Clutch w/Steel Chain	\$10.00 NET
Rollease R-Series Clutch R8/R16/R24	\$0.00
External Aluminum Hembar	\$10.00
Wrapped Hembar	\$15.00
Spring Assisted Clutch	\$125.00
*Exterior Guide Cable System	\$200.00
Bottom-Up Shade w/Clutch	\$275.00
Multiple Band Motorized Shades	
1. Price each band separately and add together	
2. Price each coupler surcharge and add together	
3. Add shade band and coupler prices together	
Straight Line Coupler	\$100.00
90° Corner Coupler	\$200.00

* Fascia Required for an additional charge.

Important Items To Note:

Screen fabrics will be fabricated vertically or horizontally (railroaded) at the factory's discretion or as noted on the price table above. Any shades wider and longer than the fabric's width will have one or more visible seams (splices).
The maximum warranted size of a clutch operated shade is 126" x 144".
Large Clutch shades may require a spring assisted lifting mechanism. Please refer to the manual clutch & tube matrix to determine if a spring assist is required.
Side channel surcharge includes left & right channels. Seal brushes available upon request.
Prices for valances, boxes, and pockets include all brackets and end caps.
Reverse roll option is not available for square, round, or wrapped fabric fascias.
The size of a shade will determine the size of the tube used, upgrades to larger tubes will be available upon request. Please refer to the manual/motorized clutch & tube matrix for specifics.
Shades exceeding a 3-to-1 ratio may have problems tracking. In other words, shades with a height dimension that is more than 3 times the width measurement may be susceptible to telescoping.
ALL MEASUREMENTS ARE BRACKET-TO-BRACKET

Shades up to 102" in width shipped via FedEx: \$4.00 / unit Net Freight Charge
Shades 102-1/8" to 125" in width shipped via FedEx: \$ 75.00 / unit Net Freight Charge
Shades 125 1/8" or greater in width shipped via Common Carrier: \$ 150.00 per shipment
Manufacturing specifications, options, surcharges and pricing are subject to change without notice.
Visit www.mariak.com for the most recent downloads.
All prices are in U.S. Dollars and do not include freight, duties or taxes for shipments to Alaska, Hawaii or Canada. GST and VAT are not included. Other restrictions and surcharges may apply. See Freight Policy for complete details.

Sun Control Roller Shades

EconoScreen 1%	1% Open	98" or 118" Wide Fabric	Polyester / PVC
Genoa (PVC Free/No Railroading)	N/A	108" Wide Fabric	Polyester
SheerWeave 7500 (Lead & PVC Free/No Railroading)	0% Open	118" Wide Fabric	Polyester/Acrylic

Length	Width													Side Channels
	24	36	48	60	72	84	96	108	116	120	132	144	156	
36	113	143	192	224	286	314	350	552	700	700	760	826	1125	70
48	122	156	201	248	299	331	401	553	760	760	767	831	1131	93
60	137	173	212	257	311	366	427	556	706	706	770	835	1136	116
72	146	188	227	270	340	400	462	582	708	708	774	838	1138	139
84	155	202	249	296	367	433	492	698	895	895	983	1062	1396	162
96	191	243	297	347	400	471	533	826	903	903	994	1075	1414	185
108	201	257	314	372	426	505	567	830	904	904	998	1078	1418	208
116	224	278	333	393	455	538	600	832	909	909	1005	1078	1425	231
120	224	278	333	393	455	538	600	832	909	909	1005	1088	1425	231
132	260	325	385	455	519	614	635	984	1077	1077	1189	1288	1654	254
144	273	338	406	477	548	648	671	986	1086	1086	1195	1293	1660	277
156	311	393	477	564	649	772	804	998	1099	1099	1345	1456	1686	300

EconoScreen - Shades under the dashed line will be railroaded and have a visible seam

Genoa - Maximum Width Single Shade 106"

SheerWeave 7500 - Maximum Width Single Shade 116"

Fascia & Headbox Accessories

	Width												
	24	36	48	60	72	84	96	108	116	120	132	144	156
Additional Options:	24	36	48	60	72	84	96	108	116	120	132	144	156
3" & 4" Square Aluminum	45	55	65	75	85	95	105	115	125	125	135	145	155
3" & 4" Round Aluminum	45	55	65	75	85	95	105	115	125	125	135	145	155
3" & 4" Fabric Wrapped	89	110	131	152	173	194	215	236	257	257	278	299	320
Shade Pocket (No Lip)	132	169	206	243	280	319	355	391	428	428	465	502	539
Shade Pocket with Lip	132	169	206	243	280	319	355	391	428	428	465	502	539
Dual Shade Pocket (No Lip)	210	289	368	447	526	605	684	763	842	842	921	1000	1079
Closure Plate for Pocket	17	24	31	38	45	50	58	66	73	73	80	87	94
Hanger with Closure Plate	21	33	45	57	69	81	93	105	117	117	129	141	153
Inserted Fabric Valance	24	30	36	42	48	54	60	66	72	72	78	84	90
Ceiling "L" Fascia	51	70	89	108	127	146	165	184	203	203	222	241	260
Sill Channel	24	35	46	57	68	79	90	101	112	112	123	134	145
Cassette Commercial	100	140	180	220	260	300	340	N/A	N/A	N/A	N/A	N/A	N/A
Cassette Retail	63	82	101	120	139	158	177	N/A	N/A	N/A	N/A	N/A	N/A

Roller Shade Surcharge Options	
Stainless Steel Chain	\$12.00
White or Black Steel Chain	\$24.00
Platinum Clutch w/Steel Chain	\$10.00 NET
Rollease R-Series Clutch R8/R16/R2	\$0.00
External Aluminum Hembar	\$10.00
Wrapped Hembar	\$15.00
Spring Assisted Clutch	\$125.00
*Exterior Guide Cable System	\$200.00
Bottom-Up Shade w/Clutch	\$275.00
Multiple Band Motorized Shades	
1. Price each band separately and add together	
2. Price each coupler surcharge and add together	
3. Add shade band and coupler prices together	
Straight Line Coupler	\$100.00
90° Corner Coupler	\$200.00

* Fascia Required for an additional charge.

Important Items To Note:

Screen fabrics will be fabricated vertically or horizontally (railroaded) at the factory's discretion or as noted on the price table above. Any shades wider and longer than the fabric's width will have one or more visible seams (splices).

The maximum warranted size of a clutch operated shade is 126" x 144".

Large Clutch shades may require a spring assisted lifting mechanism. Please refer to the manual clutch & tube matrix to determine if a spring assist is required.

Side channel surcharge includes left & right channels. Seal brushes available upon request.

Prices for valances, boxes, and pockets include all brackets and end caps.

Reverse roll option is not available for square, round, or wrapped fabric fascias.

The size of a shade will determine the size of the tube used; upgrades to larger tubes will be available upon request. Please refer to the manual/motorized clutch & tube matrix for specifics.

Shades exceeding a 3-to-1 ratio may have problems tracking. In other words, shades with a height dimension that is more than 3 times the width measurement may be susceptible to

ALL MEASUREMENTS ARE BRACKET-TO-BRACKET

Shades up to 102" in width shipped via FedEx: \$4.00 / unit Net Freight Charge
Shades 102-1/8" to 125" in width shipped via FedEx: \$ 75.00 / unit Net Freight Charge
Shades 125 1/8" or greater in width shipped via Common Carrier: \$ 150.00 per shipment
Manufacturing specifications, options, surcharges and pricing are subject to change without notice.
Visit www.mariak.com for the most recent downloads.

All prices are in U.S. Dollars and do not include freight, duties or taxes for shipments to Alaska, Hawaii or Canada. GST and VAT are not included. Other restrictions and surcharges may apply. See Freight Policy for complete details.

SheerWeave 2410 (Lead Free)	3% Open	98" Wide Fabric	Fiberglass / PVC
SheerWeave 2703 (Lead Free)	3% Open	98" Wide Fabric	Fiberglass / PVC
SheerWeave 4400 (Lead Free)	3% Open	98" Wide Fabric	Polyester / PVC
SheerWeave 4600 (Lead Free)	3% Open	98" Wide Fabric	Polyester / PVC
Siena (Lead & PVC Free)	DISCONTINUED	7% Open	118" Wide Fabric
			Polyester

Special order fabric widths must be indicated at the time of ordering and Mariak will not assume responsibility for selecting special order fabric widths

Length	Width													Side Channels
	24	36	48	60	72	84	96	108	116	120	132	144	156	
36	117	147	180	211	271	311	328	418	732	732	796	865	1180	70
48	127	163	198	233	300	347	364	578	734	734	804	871	1187	93
60	141	180	220	258	325	383	445	580	740	740	808	876	1191	116
72	151	195	238	281	356	416	482	583	742	742	811	879	1195	139
84	162	212	259	307	384	454	517	608	940	940	1030	1112	1465	162
96	197	253	308	362	416	493	556	865	947	947	1043	1127	1482	185
108	211	270	328	387	444	528	593	868	950	950	1047	1131	1489	208
116	233	290	350	413	476	564	629	872	954	954	1054	1141	1496	231
120	233	290	350	413	476	564	629	872	954	954	1054	1141	1496	231
132	273	340	404	475	544	642	665	1031	1129	1129	1247	1351	1736	254
144	283	355	423	498	574	680	701	1033	1138	1138	1254	1358	1742	277
156	326	413	498	590	682	810	843	1047	1152	1152	1411	1528	1768	300

SW2410, SW2703, SW4400 & SW4600 - Shades under the double line will be railroaded and have a visible seam

Fascia & Headbox Accessories

	Width												
Additional Options:	24	36	48	60	72	84	96	108	116	120	132	144	156
3" & 4" Square Aluminum	45	55	65	75	85	95	105	115	125	125	135	145	155
3" & 4" Round Aluminum	45	55	65	75	85	95	105	115	125	125	135	145	155
3" & 4" Fabric Wrapped	89	110	131	152	173	194	215	236	257	257	278	299	320
Shade Pocket (No Lip)	132	169	206	243	280	319	355	391	428	428	465	502	539
Shade Pocket with Lip	132	169	206	243	280	319	355	391	428	428	465	502	539
Dual Shade Pocket (No Lip)	210	289	368	447	526	605	684	763	842	842	921	1000	1079
Closure Plate for Pocket	17	24	31	38	45	50	58	66	73	73	80	87	94
Hanger with Closure Plate	21	33	45	57	69	81	93	105	117	117	129	141	153
Inserted Fabric Valance	24	30	36	42	48	54	60	66	72	72	78	84	90
Ceiling "L" Fascia	51	70	89	108	127	146	165	184	203	203	222	241	260
Sill Channel	24	35	46	57	68	79	90	101	112	112	123	134	145
Cassette Commercial	100	140	180	220	260	300	340	N/A	N/A	N/A	N/A	N/A	N/A
Cassette Retail	63	82	101	120	139	158	177	N/A	N/A	N/A	N/A	N/A	N/A

Roller Shade Surcharge Options	
Stainless Steel Chain	\$12.00
White or Black Steel Chain	\$24.00
Platinum Clutch w/Steel Chain	\$10.00 NET
Rollease R-Series Clutch R8/R16/R24	\$0.00
External Aluminum Hembar	\$10.00
Wrapped Hembar	\$15.00
Spring Assisted Clutch	\$125.00
*Exterior Guide Cable System	\$200.00
Bottom-Up Shade w/Clutch	\$275.00
Multiple Band Motorized Shades	
1. Price each band separately and add together	
2. Price each coupler surcharge and add together	
3. Add shade band and coupler prices together	
Straight Line Coupler	\$100.00
90° Corner Coupler	\$200.00

* Fascia Required for an additional charge.

Important Items To Note:

Screen fabrics will be fabricated vertically or horizontally (railroaded) at the factory's discretion or as noted on the price table above. Any shades wider and longer than the fabric's width will have one or more visible seams (splices).
The maximum warranted size of a clutch operated shade is 126" x 144".
Large Clutch shades may require a spring assisted lifting mechanism. Please refer to the manual clutch & tube matrix to determine if a spring assist is required.
Side channel surcharge includes left & right channels. Seal brushes available upon request.
Prices for valances, boxes, and pockets include all brackets and end caps.
Reverse roll option is not available for square, round, or wrapped fabric fascias.
The size of a shade will determine the size of the tube used; upgrades to larger tubes will be available upon request. Please refer to the manual/motorized clutch & tube matrix for specifics.
Shades exceeding a 3-to-1 ratio may have problems tracking. In other words, shades with a height dimension that is more than 3 times the width measurement may be susceptible to telescoping.
ALL MEASUREMENTS ARE BRACKET-TO-BRACKET

Shades up to 102" in width shipped via FedEx: \$4.00 / unit Net Freight Charge
Shades 102-1/8" to 125" in width shipped via FedEx: \$ 75.00 / unit Net Freight Charge
Shades 125 1/8" or greater in width shipped via Common Carrier: \$ 150.00 per shipment
Manufacturing specifications, options, surcharges and pricing are subject to change without notice.
Visit www.mariak.com for the most recent downloads.
All prices are in U.S. Dollars and do not include freight, duties or taxes for shipments to Alaska, Hawaii or Canada. GST and VAT are not included. Other restrictions and surcharges may apply. See Freight Policy for complete details.

Sun Control Roller Shades

<i>Bordeaux (No Railroading)</i>	N/A	78" Wide Fabric	Polyester
<i>Cortina (PVC Free/No Railroading)</i> DISCONTINUED	N/A	118" Wide Fabric	Polyester
<i>Deco Screen 5% (No Railroading)</i>	N/A	98" Wide Fabric	Fiberglass/PVC
<i>M-Screen 8503 Classic & Essence Colors (No Railroading)</i>	3% Open	98" Wide Fabric	Fiberglass / PVC
<i>Montpellier (PVC Free/No Railroading)</i>	N/A	110" Wide Fabric	Polyester/Acrylic
<i>Munich Blackout (PVC Free/No Railroading)</i> DISCONTINUED	0% Open	94" Wide Fabric	Polyester/Acrylic
<i>Zurich Blackout (No Railroading)</i>	0% Open	110" Wide Fabric	Polyester/Foa

		Width												Side Channels	
		24	36	48	60	72	84	96	108	116	120	132	144	156	
Length	36	117	147	180	211	271	311	328	418	732	Grid does not apply beyond this point				70
	48	127	163	198	233	300	347	364	578	734					93
	60	141	180	220	258	325	383	445	580	740					116
	72	151	195	238	281	356	416	482	583	742					139
	84	162	212	259	307	384	454	517	608	940					162
	96	197	253	308	362	416	493	556	865	947					185
	108	211	270	328	387	444	528	593	868	950					208
	116	233	290	350	413	476	564	629	872	954					231
	120	233	290	350	413	476	564	629	872	954					231
	132	273	340	404	475	544	642	665	1031	1129					254
	144	283	355	423	498	574	680	701	1033	1138					277
	156	326	413	498	590	682	810	843	1047	1152					300

Bordeaux - Maximum Width Single Shade 76"
Deco Screen & M-Screen 8503 - Maximum Width Single Shade 96"
Montpellier & Zurich Blackout - Maximum Width Single Shade 108"

Fascia & Headbox Accessories

	Width												
	24	36	48	60	72	84	96	108	116	120	132	144	156
Additional Options:													
3" & 4" Square Aluminum	45	55	65	75	85	95	105	115	125	125	135	145	155
3" & 4" Round Aluminum	45	55	65	75	85	95	105	115	125	125	135	145	155
3" & 4" Fabric Wrapped	89	110	131	152	173	194	215	236	257	257	278	299	320
Shade Pocket (No Lip)	132	169	206	243	280	319	355	391	428	428	465	502	539
Shade Pocket with Lip	132	169	206	243	280	319	355	391	428	428	465	502	539
Dual Shade Pocket (No Lip)	210	289	368	447	526	605	684	763	842	842	921	1000	1079
Closure Plate for Pocket	17	24	31	38	45	50	58	66	73	73	80	87	94
Hanger with Closure Plate	21	33	45	57	69	81	93	105	117	117	129	141	153
Inserted Fabric Valance	24	30	36	42	48	54	60	66	72	72	78	84	90
Ceiling "L" Fascia	51	70	89	108	127	146	165	184	203	203	222	241	260
Sill Channel	24	35	46	57	68	79	90	101	112	112	123	134	145
Cassette Commercial	100	140	180	220	260	300	340	N/A	N/A	N/A	N/A	N/A	N/A
Cassette Retail	63	82	101	120	139	158	177	N/A	N/A	N/A	N/A	N/A	N/A

Roller Shade Surcharge Options	
Stainless Steel Chain	\$12.00
White or Black Steel Chain	\$24.00
Platinum Clutch w/Steel Chain	\$10.00 NET
Rollease R-Series Clutch R8/R16/R24	\$0.00
External Aluminum Hembar	\$10.00
Wrapped Hembar	\$15.00
Spring Assisted Clutch	\$125.00
* Exterior Guide Cable System	\$200.00
Bottom-Up Shade w/Clutch	\$275.00
Multiple Band Motorized Shades	
1. Price each band separately and add together	
2. Price each coupler surcharge and add together	
3. Add shade band and coupler prices together	
Straight Line Coupler	\$100.00
90° Corner Coupler	\$200.00

Important Items To Note:

Screen fabrics will be fabricated vertically or horizontally (railroaded) at the factory's discretion or as noted on the price table above. Any shades wider and longer than the fabric's width will have one or more visible seams (splices).
The maximum warrantied size of a clutch operated shade is 126" x 144".
Large Clutch shades may require a spring assisted lifting mechanism. Please refer to the manual clutch & tube matrix to determine if a spring assist is required.
Side channel surcharge includes left & right channels. Seal brushes available upon request.
Prices for valances, boxes, and pockets include all brackets and end caps.
Reverse roll option is not available for square, round, or wrapped fabric fascias.
The size of a shade will determine the size of the tube used; upgrades to larger tubes will be available upon request. Please refer to the manual/motorized clutch & tube matrix for specifics.
Shades exceeding a 3-to-1 ratio may have problems tracking. In other words, shades with a height dimension that is more than 3 times the width measurement may be susceptible to telescoping.
ALL MEASUREMENTS ARE BRACKET-TO-BRACKET

* Fascia Required for an additional charge.

Shades up to 102" in width shipped via FedEx: \$4.00 / unit Net Freight Charge
Shades 102-8" to 125" in width shipped via FedEx: \$ 75.00 / unit Net Freight Charge
Shades 125 1/8" or greater in width shipped via Common Carrier: \$ 150.00 per shipment
Manufacturing specifications, options, surcharges and pricing are subject to change without notice.
Visit www.mariak.com for the most recent downloads.
All prices are in U.S. Dollars and do not include freight, duties or taxes for shipments to Alaska, Hawaii or Canada. GST and VAT are not included. Other restrictions and surcharges may apply. See Freight Policy for complete details.

Sun Control Roller Shades

Vela (Lead, Mercury & PVC Free/No Railroading) DISCONTINUED 3% Open 118" Wide Fabric Polyester

Length	Width												Side Channels	
	24	36	48	60	72	84	96	108	116	118	132	144		156
36	121	153	189	219	282	326	343	361	379	Grid does not apply beyond this point				70
48	134	170	207	244	311	362	379	400	421					93
60	146	189	230	271	340	400	465	489	516					116
72	156	204	250	295	372	434	505	531	560					139
84	168	220	272	321	401	474	540	568	597					162
96	206	264	322	377	434	516	583	613	644					185
108	219	281	343	406	464	551	620	653	687					208
116	244	304	366	431	497	588	656	690	727					231
120	244	304	366	431	497	588	656	690	727					231
132	284	354	421	496	568	672	695	732	770					254
144	297	371	441	520	598	709	733	772	812					277
156	341	431	520	617	711	845	880	926	974					300

Vela - Maximum Width Single Shade 116"

Fascia & Headbox Accessories

	Width													
	24	36	48	60	72	84	96	108	116	120	132	144	156	
Additional Options:	24	36	48	60	72	84	96	108	116	120	132	144	156	
3" & 4" Square Aluminum	45	55	65	75	85	95	105	115	125	125	135	145	155	
3" & 4" Round Aluminum	45	55	65	75	85	95	105	115	125	125	135	145	155	
3" & 4" Fabric Wrapped	89	110	131	152	173	194	215	236	257	257	278	299	320	
Shade Pocket (No Lip)	132	169	206	243	280	319	355	391	428	428	465	502	539	
Shade Pocket with Lip	132	169	206	243	280	319	355	391	428	428	465	502	539	
Dual Shade Pocket (No Lip)	210	289	368	447	526	605	684	763	842	842	921	1000	1079	
Closure Plate for Pocket	17	24	31	38	45	50	58	66	73	73	80	87	94	
Hanger with Closure Plate	21	33	45	57	69	81	93	105	117	117	129	141	153	
Inserted Fabric Valance	24	30	36	42	48	54	60	66	72	72	78	84	90	
Ceiling "L" Fascia	51	70	89	108	127	146	165	184	203	203	222	241	260	
Sill Channel	24	35	46	57	68	79	90	101	112	112	123	134	145	
Cassette Commercial	100	140	180	220	260	300	340	N/A	N/A	N/A	N/A	N/A	N/A	
Cassette Retail	63	82	101	120	139	158	177	N/A	N/A	N/A	N/A	N/A	N/A	

Roller Shade Surcharge Options	
Stainless Steel Chain	\$12.00
White or Black Steel Chain	\$24.00
Platinum Clutch w/Steel Chain	\$10.00 NET
Rollease R-Series Clutch R8/R16/R24	\$0.00
External Aluminum Hembar	\$10.00
Wrapped Hembar	\$15.00
Spring Assisted Clutch	\$125.00
*Exterior Guide Cable System	\$200.00
Bottom-Up Shade w/Clutch	\$275.00
Multiple Band Motorized Shades	
1. Price each band separately and add together	
2. Price each coupler surcharge and add together	
3. Add shade band and coupler prices together	
Straight Line Coupler	\$100.00
90° Corner Coupler	\$200.00

* Fascia Required for an additional charge.

Important Items To Note:

Screen fabrics will be fabricated vertically or horizontally (railroaded) at the factory's discretion or as noted on the price table above. Any shades wider and longer than the fabric's width will have one or more visible seams (splices).
The maximum warranted size of a clutch operated shade is 126" x 144".
Large Clutch shades may require a spring assisted lifting mechanism. Please refer to the manual clutch & tube matrix to determine if a spring assist is required.
Side channel surcharge includes left & right channels. Seal brushes available upon request.
Prices for valances, boxes, and pockets include all brackets and end caps.
Reverse roll option is not available for square, round, or wrapped fabric fascias.
The size of a shade will determine the size of the tube used; upgrades to larger tubes will be available upon request. Please refer to the manual/motorized clutch & tube matrix for specifics.
Shades exceeding a 3-to-1 ratio may have problems tracking. In other words, shades with a height dimension that is more than 3 times the width measurement may be susceptible to telescoping.
ALL MEASUREMENTS ARE BRACKET-TO-BRACKET

Shades up to 102" in width shipped via FedEx: \$4.00 / unit Net Freight Charge
Shades 102-1/8" to 125" in width shipped via FedEx: \$ 75.00 / unit Net Freight Charge
Shades 125 1/8" or greater in width shipped via Common Carrier: \$ 150.00 per shipment
Manufacturing specifications, options, surcharges and pricing are subject to change without notice.
Visit www.mariak.com for the most recent downloads.
All prices are in U.S. Dollars and do not include freight, duties or taxes for shipments to Alaska, Hawaii or Canada. GST and VAT are not included. Other restrictions and surcharges may apply. See Freight Policy for complete details.

Sun Control Roller Shades

Alkenz 4700P 1% Sunshadow	1% Open	98" Wide Fabric	Polyester / PVC
Belize (No Railroad)	N/A	106" Wide Fabric	Polyester
Edessa Twilight Blackout (PVC Free/No Railroad)	N/A	118" Wide Fabric	Polyester/Acrylic
E-Screen 7503 3%	3% Open	98" Wide Fabric	Fiberglass/PVC
Naples (No Railroad)	N/A	106" Wide Fabric	Polyester
Naturale (PVC Free, Recycled Materials & 100% Recyclable/No Railroad)	N/A	106" Wide Fabric	Polyester
SheerWeave 2500 (Lead Free)	1% Open	98" Wide Fabric	Fiberglass / PVC
SheerWeave 2701 (Lead Free)	1% Open	98" Wide Fabric	Fiberglass / PVC
SheerWeave 4800 (Lead Free)	1% Open	96" Wide Fabric	Fiberglass / PVC

Special order fabric widths must be indicated at the time of ordering and Mariak will not assume responsibility for selecting special order fabric widths

Length	Width														Side Channels
	24	36	48	60	72	84	94	96	108	120	132	144	156		
36	125	160	195	227	293	337	355	355	452	791	861	934	1276	70	
48	139	175	214	253	323	374	393	393	623	793	868	942	1283	93	
60	151	195	238	279	351	414	482	482	627	799	872	946	1287	116	
72	163	211	257	304	384	450	522	522	630	801	877	949	1290	139	
84	174	228	280	331	415	488	558	558	657	1014	1112	1203	1582	162	
94	213	273	332	390	450	533	602	602	934	1023	1126	1217	1601	185	
96	213	273	332	390	450	533	602	602	934	1023	1126	1217	1601	185	
108	227	290	355	419	480	570	641	641	940	1025	1130	1222	1608	208	
120	253	315	377	445	513	608	680	680	943	1031	1138	1232	1616	231	
132	296	367	435	512	588	694	719	719	1113	1220	1347	1462	1876	254	
144	306	383	458	538	620	734	758	758	1117	1230	1354	1466	1882	277	
156	352	445	538	638	736	874	910	910	1130	1244	1524	1651	1910	300	

Alkenz 4700P, E-Screen 7503, SW2500, SW2701- Shades under the dashed line will be railroaded and have a visible seam

Belize - Maximum Shade Width is 104"

Edessa Twilight - Maximum Shade Width 116"

Naples & Naturale - Maximum Shade Width 104"

SheerWeave 4800 - Shades under the double line will be railroaded and have a visible seam

Fascia & Headbox Accessories

	Width													
Additional Options:	24	36	48	60	72	84	94	96	108	120	132	144	156	
3" & 4" Square Aluminum	45	55	65	75	85	95	105	105	115	125	135	145	155	
3" & 4" Round Aluminum	45	55	65	75	85	95	105	105	115	125	135	145	155	
3" & 4" Fabric Wrapped	89	110	131	152	173	194	215	215	236	257	278	299	320	
Shade Pocket (No Lip)	132	169	206	243	280	319	355	355	391	428	465	502	539	
Shade Pocket with Lip	132	169	206	243	280	319	355	355	391	428	465	502	539	
Dual Shade Pocket (No Lip)	210	289	368	447	526	605	684	684	763	842	921	1000	1079	
Closure Plate for Pocket	17	24	31	38	45	50	58	58	66	73	80	87	94	
Hanger with Closure Plate	21	33	45	57	69	81	93	93	105	117	129	141	153	
Inserted Fabric Valance	24	30	36	42	48	54	60	60	66	72	78	84	90	
Ceiling "L" Fascia	51	70	89	108	127	146	165	165	184	203	222	241	260	
Sill Channel	24	35	46	57	68	79	90	90	101	112	123	134	145	
Cassette Commercial	100	140	180	220	260	300	340	340	N/A	N/A	N/A	N/A	N/A	
Cassette Retail	63	82	101	120	139	158	177	177	N/A	N/A	N/A	N/A	N/A	

Roller Shade Surcharge Options	
Stainless Steel Chain	\$12.00
White or Black Steel Chain	\$24.00
Platinum Clutch w/Steel Chain	\$10.00 NET
Rollease R-Series Clutch R8/R16/R24	\$0.00
External Aluminum Hembar	\$10.00
Wrapped Hembar	\$15.00
Spring Assisted Clutch	\$125.00
*Exterior Guide Cable System	\$200.00
Bottom-Up Shade w/Clutch	\$275.00
Multiple Band Motorized Shades	
1. Price each band separately and add together	
2. Price each coupler surcharge and add together	
3. Add shade band and coupler prices together	
Straight Line Coupler	\$100.00
90° Corner Coupler	\$200.00

Important Items To Note:

Screen fabrics will be fabricated vertically or horizontally (railroaded) at the factory's discretion or as noted on the price table above. Any shades wider and longer than the fabric's width will have one or more visible seams (splices).
The maximum warranted size of a clutch operated shade is 126" x 144".
Large Clutch shades may require a spring assisted lifting mechanism. Please refer to the manual clutch & tube matrix to determine if a spring assist is required.
Side channel surcharge includes left & right channels. Seal brushes available upon request.
Prices for valances, boxes, and pockets include all brackets and end caps.
Reverse roll option is not available for square, round, or wrapped fabric fascias.
The size of a shade will determine the size of the tube used; upgrades to larger tubes will be available upon request. Please refer to the manual/motorized clutch & tube matrix for specifics.
Shades exceeding a 3-to-1 ratio may have problems tracking. In other words, shades with a height dimension that is more than 3 times the width measurement may be susceptible to telescoping.
ALL MEASUREMENTS ARE BRACKET-TO-BRACKET

* Fascia Required for an additional charge.

Shades up to 102" in width shipped via FedEx: \$4.00 / unit Net Freight Charge
Shades 102-1/8" to 125" in width shipped via FedEx: \$ 75.00 / unit Net Freight Charge
Shades 125 1/8" or greater in width shipped via Common Carrier: \$ 150.00 per shipment
Manufacturing specifications, options, surcharges and pricing are subject to change without notice.
Visit www.mariak.com for the most recent downloads.
All prices are in U.S. Dollars and do not include freight, duties or taxes for shipments to Alaska, Hawaii or Canada. GST and VAT are not included. Other restrictions and surcharges may apply. See Freight Policy for complete details.

Sun Control Roller Shades

SheerWeave 5000 (Lead Free/No Railroading) Varies by Color 98" Wide Fabric Fiberglass / PVC

Length	Width											Side Channels		
	24	36	48	60	72	84	96	108	120	132	144		156	
36	125	160	195	227	293	337	355	Grid does not apply beyond this point						70
48	139	175	214	253	323	374	393							93
60	151	195	238	279	351	414	482							116
72	163	211	257	304	384	450	522							139
84	174	228	280	331	415	488	558							162
96	213	273	332	390	450	533	602							185
108	227	290	355	419	480	570	641							208
120	253	315	377	445	513	608	680							231
132	296	367	435	512	588	694	719							254
144	306	383	458	538	620	734	758							277
156	352	445	538	638	736	874	910							300

SheerWeave 5000 - Maximum Width Single Shade 96"

Fascia & Headbox Accessories

	Width											
	24	36	48	60	72	84	96	108	120	132	144	156
Additional Options:												
3" & 4" Square Aluminum	45	55	65	75	85	95	105	115	125	135	145	155
3" & 4" Round Aluminum	45	55	65	75	85	95	105	115	125	135	145	155
3" & 4" Fabric Wrapped	89	110	131	152	173	194	215	236	257	278	299	320
Shade Pocket (No Lip)	132	169	206	243	280	319	355	391	428	465	502	539
Shade Pocket with Lip	132	169	206	243	280	319	355	391	428	465	502	539
Dual Shade Pocket (No Lip)	210	289	368	447	526	605	684	763	842	921	1000	1079
Closure Plate for Pocket	17	24	31	38	45	50	58	66	73	80	87	94
Hanger with Closure Plate	21	33	45	57	69	81	93	105	117	129	141	153
Inserted Fabric Valance	24	30	36	42	48	54	60	66	72	78	84	90
Ceiling "L" Fascia	51	70	89	108	127	146	165	184	203	222	241	260
Sill Channel	24	35	46	57	68	79	90	101	112	123	134	145
Cassette Commercial	100	140	180	220	260	300	340	N/A	N/A	N/A	N/A	N/A
Cassette Retail	63	82	101	120	139	158	177	N/A	N/A	N/A	N/A	N/A

Roller Shade Surcharge Options	
Stainless Steel Chain	\$12.00
White or Black Steel Chain	\$24.00
Platinum Clutch w/Steel Chain	\$10.00 NET
Rollease R-Series Clutch R8/R16/R24	\$0.00
External Aluminum Hembar	\$10.00
Wrapped Hembar	\$15.00
Spring Assisted Clutch	\$125.00
*Exterior Guide Cable System	\$200.00
Bottom-Up Shade w/Clutch	\$275.00
Multiple Band Motorized Shades	
1. Price each band separately and add together	
2. Price each coupler surcharge and add together	
3. Add shade band and coupler prices together	
Straight Line Coupler	\$100.00
90° Corner Coupler	\$200.00

Important Items To Note:
Screen fabrics will be fabricated vertically or horizontally (railroaded) at the factory's discretion or as noted on the price table above. Any shades wider and longer than the fabric's width will have one or more visible seams (splices).
The maximum warranted size of a clutch operated shade is 126" x 144".
Large Clutch shades may require a spring assisted lifting mechanism. Please refer to the manual clutch & tube matrix to determine if a spring assist is required.
Side channel surcharge includes left & right channels. Seal brushes available upon request.
Prices for valances, boxes, and pockets include all brackets and end caps.
Reverse roll option is not available for square, round, or wrapped fabric fascias.
The size of a shade will determine the size of the tube used; upgrades to larger tubes will be available upon request. Please refer to the manual/motorized clutch & tube matrix for specifics.
Shades exceeding a 3-to-1 ratio may have problems tracking. In other words, shades with a height dimension that is more than 3 times the width measurement may be susceptible to telescoping.
All measurements must be bracket to bracket.

* Fascia Required for an additional charge.

Shades up to 102" in width shipped via FedEx: \$4.00 / unit Net Freight Charge
Shades 102-125" in width shipped via FedEx: \$ 75.00 / unit Net Freight Charge
Shades 125 1/8" or greater in width shipped via Common Carrier: \$ 150.00 per shipment
Manufacturing specifications, options, surcharges and pricing are subject to change without notice.
Visit www.mariak.com for the most recent downloads.
All prices are in U.S. Dollars and do not include freight, duties or taxes for shipments to Alaska, Hawaii or Canada. GST and VAT are not included. Other restrictions and surcharges may apply. See Freight Policy for complete details.

Sun Control Roller Shades

Alkenz 3000 CA 3% Sunshadow	3% Open	98" Wide Fabric	Polyester / PVC
Alkenz 4700Q 1% Sunshadow DISCONTINUED	1% Open	98" Wide Fabric	Polyester / PVC
ColorVision	5% Open	98" Wide Fabric	Polyester
E-Screen 7501 1%	1% Open	98" Wide Fabric	Fiberglass/PVC
Palermo Blackout	0% Open	110" Wide Fabric	Polyester
Princess (PVC Free/No Railroad)	N/A	79" Wide Fabric	Polyester/Acrylic
SheerWeave 7100 Blackout (Lead Free/No Railroad)	0% Open	96" Wide Fabric	Fiberglass / PVC Laminated

Special order fabric widths must be indicated at the time of ordering and Mariak will not assume responsibility for selecting special order fabric widths

Length	Width											Side Channels	
	24	36	48	60	72	84	96	108	120	132	144		156
36	130	166	203	236	304	351	369	468	820	895	972	1325	70
48	145	182	222	263	334	388	409	648	824	902	978	1333	93
60	159	203	248	290	366	431	500	652	831	905	983	1337	116
72	169	219	267	317	401	466	542	654	834	910	986	1341	139
84	181	237	294	346	432	509	580	683	1054	1157	1251	1644	162
96	221	283	348	408	466	553	628	972	1063	1170	1265	1663	185
108	236	303	369	435	500	593	667	975	1065	1175	1272	1670	208
120	263	327	394	463	533	634	706	978	1073	1184	1280	1679	231
132	307	381	454	533	612	722	746	1158	1268	1399	1519	1950	254
144	320	399	476	561	644	763	788	1161	1279	1408	1525	1957	277
156	368	463	561	664	766	908	946	1175	1292	1584	1714	1985	300

Alkenz 3000, ColorVision & E-Screen 7501 - Shades under the double line will be railroaded and have a SheerWeave 7100 - Maximum Width Single Shade 94"
 Palermo Blackout - Shades under the dashed line will be railroaded and have a visible seam
 Princess - Maximum Width Single Shade 77"

Fascia & Headbox Accessories

	Width											
	24	36	48	60	72	84	96	108	120	132	144	156
Additional Options:												
3" & 4" Square Aluminum	45	55	65	75	85	95	105	115	125	135	145	155
3" & 4" Round Aluminum	45	55	65	75	85	95	105	115	125	135	145	155
3" & 4" Fabric Wrapped	89	110	131	152	173	194	215	236	257	278	299	320
Shade Pocket (No Lip)	132	169	206	243	280	319	355	391	428	465	502	539
Shade Pocket with Lip	132	169	206	243	280	319	355	391	428	465	502	539
Dual Shade Pocket (No Lip)	210	289	368	447	526	605	684	763	842	921	1000	1079
Closure Plate for Pocket	17	24	31	38	45	50	58	66	73	80	87	94
Hanger with Closure Plate	21	33	45	57	69	81	93	105	117	129	141	153
Inserted Fabric Valance	24	30	36	42	48	54	60	66	72	78	84	90
Ceiling "L" Fascia	51	70	89	108	127	146	165	184	203	222	241	260
Sill Channel	24	35	46	57	68	79	90	101	112	123	134	145
Cassette Commercial	100	140	180	220	260	300	340	N/A	N/A	N/A	N/A	N/A
Cassette Retail	63	82	101	120	139	158	177	N/A	N/A	N/A	N/A	N/A

Roller Shade Surcharge Options	Price	Important Items To Note:
Stainless Steel Chain	\$12.00	Screen fabrics will be fabricated vertically or horizontally (railroaded) at the factory's discretion or as noted on the price table above. Any shades wider and longer than the fabric's width will have one or more visible seams (splices).
White or Black Steel Chain	\$24.00	
Platinum Clutch w/Steel Chain	\$10.00 NET	The maximum warranted size of a clutch operated shade is 126" x 144".
Rollease R-Series Clutch R8/R16/R24	\$0.00	
External Aluminum Hembar	\$10.00	Large Clutch shades may require a spring assisted lifting mechanism. Please refer to the manual clutch & tube matrix to determine if a spring assist is required.
Wrapped Hembar	\$15.00	
Spring Assisted Clutch	\$125.00	Side channel surcharge includes left & right channels. Seal brushes available upon request.
*Exterior Guide Cable System	\$200.00	
Bottom-Up Shade w/Clutch	\$275.00	Prices for valances, boxes, and pockets include all brackets and end caps.
Multiple Band Motorized Shades		Reverse roll option is not available for square, round, or wrapped fabric fascias.
1. Price each band separately and add together		The size of a shade will determine the size of the tube used; upgrades to larger tubes will be available upon request. Please refer to the manual/motorized clutch & tube matrix for specifics.
2. Price each coupler surcharge and add together		
3. Add shade band and coupler prices together		
Straight Line Coupler	\$100.00	Shades exceeding a 3-to-1 ratio may have problems tracking. In other words, shades with a height dimension that is more than 3 times the width measurement may be susceptible to telescoping.
90° Corner Coupler	\$200.00	
ALL MEASUREMENTS ARE BRACKET-TO-BRACKET		

* Fascia Required for an additional charge.

Shades up to 102" in width shipped via FedEx: \$4.00 / unit Net Freight Charge
Shades 102-1/8" to 125" in width shipped via FedEx: \$ 75.00 / unit Net Freight Charge
Shades 125 1/8" or greater in width shipped via Common Carrier: \$ 150.00 per shipment
Manufacturing specifications, options, surcharges and pricing are subject to change without notice.
Visit www.mariak.com for the most recent downloads.
All prices are in U.S. Dollars and do not include freight, duties or taxes for shipments to Alaska, Hawaii or Canada. GST and VAT are not included. Other restrictions and surcharges may apply. See Freight Policy for complete details.

Sun Control Roller Shades

Cross Hatch (PVC Free/No Railroading)	N/A	79" Wide Fabric	Polyester
Dublin (No Railroading)	N/A	98" Wide Fabric	Polyester
Florence (PVC Free/No Railroading)	N/A	72" Wide Fabric	Polyester/Foam
Jerusalem (PVC Free - No Railroading)	N/A	72" Wide Fabric	Polyester/Foam
Noblette (PVC-Free/No Railroading)	Translucent	110" Wide Fabric	Polyester
Salon (PVC Free/No Railroading)	N/A	79" Wide Fabric	Polyester
S-Screen Origins & Elements Colors (Lead Free/No Railroading)	4% Open	98" Wide Fabric	Fiberglass
Tapestry (PVC Free/No Railroading)	N/A	79" Wide Fabric	Polyester/Acrylic
Tradewinds (PVC Free/No Railroading)	N/A	109" Wide Fabric	Polyester

Special order fabric widths must be indicated at the time of ordering and Mariak will not assume responsibility for selecting special order fabric widths

Length	Width											Side Channels	
	24	36	48	60	72	84	96	108	110	132	144		156
36	138	172	212	246	318	367	385	406	427	Grid does not apply beyond this point.			70
48	150	191	232	274	351	407	428	450	474				93
60	165	212	259	304	382	450	524	551	580				116
72	176	228	279	329	418	488	567	596	629				139
84	190	249	305	361	452	532	607	639	672				162
96	231	297	362	424	488	579	655	689	725				185
108	246	317	385	456	523	619	698	734	773				208
120	274	341	411	484	558	661	739	777	818				231
132	321	399	474	556	639	754	780	821	865				254
144	332	416	497	585	674	797	824	867	913				277
156	383	484	585	694	800	951	991	1043	1098	300			

Cross Hatch, Salon & Tapestry - Maximum Width Single Shade 77"

Dublin & S-Screen- Maximum Width Single Shade 96"

Florence, Jerusalem - Maximum Width Single Shade 70"

Noblette- Maximum Width Single Shade 108"

Tradewinds- Maximum Width Single Shade 107"

Fascia & Headbox Accessories

	Width											
	24	36	48	60	72	84	96	108	120	132	144	156
Additional Options:												
3" & 4" Square Aluminum	45	55	65	75	85	95	105	115	125	135	145	155
3" & 4" Round Aluminum	45	55	65	75	85	95	105	115	125	135	145	155
3" & 4" Fabric Wrapped	89	110	131	152	173	194	215	236	257	278	299	320
Shade Pocket (No Lip)	132	169	206	243	280	319	355	391	428	465	502	539
Shade Pocket with Lip	132	169	206	243	280	319	355	391	428	465	502	539
Dual Shade Pocket (No Lip)	210	289	368	447	526	605	684	763	842	921	1000	1079
Closure Plate for Pocket	17	24	31	38	45	50	58	66	73	80	87	94
Hanger with Closure Plate	21	33	45	57	69	81	93	105	117	129	141	153
Inserted Fabric Valance	24	30	36	42	48	54	60	66	72	78	84	90
Ceiling "L" Fascia	51	70	89	108	127	146	165	184	203	222	241	260
Sill Channel	24	35	46	57	68	79	90	101	112	123	134	145
Cassette Commercial	100	140	180	220	260	300	340	N/A	N/A	N/A	N/A	N/A
Cassette Retail	63	82	101	120	139	158	177	N/A	N/A	N/A	N/A	N/A

Roller Shade Surcharge Options	
Stainless Steel Chain	\$12.00
White or Black Steel Chain	\$24.00
Platinum Clutch w/Steel Chain	\$10.00 NET
Rollease R-Series Clutch R8/R16/R24	\$0.00
External Aluminum Hembar	\$10.00
Wrapped Hembar	\$15.00
Spring Assisted Clutch	\$125.00
*Exterior Guide Cable System	\$200.00
Bottom-Up Shade w/Clutch	\$275.00
Multiple Band Motorized Shades	
1. Price each band separately and add together	
2. Price each coupler surcharge and add together	
3. Add shade band and coupler prices together	
Straight Line Coupler	\$100.00
90° Corner Coupler	\$200.00

Important Items To Note:	
Screen fabrics will be fabricated vertically or horizontally (railroaded) at the factory's discretion or as noted on the price table above. Any shades wider and longer than the fabric's width will have one or more visible seams (splices).	
The maximum warranted size of a clutch operated shade is 126" x 144".	
Large Clutch shades may require a spring assisted lifting mechanism. Please refer to the manual clutch & tube matrix to determine if a spring assist is required.	
Side channel surcharge includes left & right channels. Seal brushes available upon request.	
Prices for valances, boxes, and pockets include all brackets and end caps.	
Reverse roll option is not available for square, round, or wrapped fabric fascias.	
The size of a shade will determine the size of the tube used; upgrades to larger tubes will be available upon request. Please refer to the manual/motorized clutch & tube matrix for specifics.	
Shades exceeding a 3-to-1 ratio may have problems tracking. In other words, shades with a height dimension that is more than 3 times the width measurement may be susceptible to telescoping.	
ALL MEASUREMENTS ARE BRACKET-TO-BRACKET	

* Stainless Steel Chain Required

Shades up to 102" in width shipped via FedEx: \$4.00 / unit Net Freight Charge
Shades 102-8" to 125" in width shipped via FedEx: \$ 75.00 / unit Net Freight Charge
Shades 125 1/8" or greater in width shipped via Common Carrier: \$ 150.00 per shipment
Manufacturing specifications, options, surcharges and pricing are subject to change without notice.
Visit www.mariak.com for the most recent downloads.
All prices are in U.S. Dollars and do not include freight, duties or taxes for shipments to Alaska, Hawaii or Canada. GST and VAT are not included. Other restrictions and surcharges may apply. See Freight Policy for complete details.

Sun Control Roller Shades

Clinique Blackout (Sanitized)	0% Open	114" Wide Fabric	Polyester
SheerWeave 7000 Blackout (Lead & PVC Free/No Railroading)	0% Open	94" Wide Fabric	Polyester / Acrylic Backing
SilverScreen (Energy Saving, Formaldehyde Free & Recyclable/No Railroading)	3% Open	94" Wide Fabric	Fiberglass
Ultimate Achievement High Performance Metalized Fabric (PVC Free)	2% & 4% Open	94" Wide Fabric	Metalized

Length	Width															Side Channels
	24	36	48	60	72	76	84	92	96	108	112	120	132	144	156	
36	170	216	264	307	396	458	458	482	482	613	1074	1074	1169	1270	1733	70
48	189	238	290	343	438	508	508	534	534	847	1077	1077	1179	1279	1745	93
60	205	264	324	379	477	563	563	654	654	851	1085	1085	1185	1284	1749	116
72	220	284	350	412	523	611	611	708	708	854	1089	1089	1190	1289	1754	139
76	236	309	381	452	564	665	665	758	758	892	1377	1377	1513	1634	2151	162
84	236	309	381	452	564	665	665	758	758	892	1377	1377	1513	1634	2151	185
92	288	371	453	530	611	724	724	817	817	1270	1390	1390	1529	1655	2177	185
96	288	371	453	530	611	724	724	817	817	1270	1390	1390	1529	1655	2177	208
108	307	395	482	569	653	774	774	872	872	1276	1393	1393	1537	1661	2186	208
112	343	427	513	606	697	827	827	922	922	1281	1400	1400	1547	1675	2196	231
120	343	427	513	606	697	827	827	922	922	1281	1400	1400	1547	1675	2196	231
132	400	498	591	696	798	944	944	975	975	1514	1658	1658	1832	1986	2550	254
144	415	520	621	731	842	997	997	1030	1030	1518	1670	1670	1839	1993	2558	277
156	479	606	731	866	1000	1188	1188	1237	1237	1537	1692	1692	2070	2243	2596	300

Clinique -Shades under the dashed line will be railroaded and have a visible seam
SheerWeave 7000 & SilverScreen - Maximum Width Single Shade 92"
Ultimate Achievement - Shades under the double line will be railroaded and have a visible seam

Fascia & Headbox Accessories

	Width														
	24	36	48	60	72	76	84	92	96	108	112	120	132	144	156
Additional Options:	24	36	48	60	72	76	84	92	96	108	112	120	132	144	156
3" & 4" Square Aluminum	45	55	65	75	85	95	95	105	105	115	125	125	135	145	155
3" & 4" Round Aluminum	45	55	65	75	85	95	95	105	105	115	125	125	135	145	155
3" & 4" Fabric Wrapped	89	110	131	152	173	194	194	215	215	236	257	257	278	299	320
Shade Pocket (No Lip)	132	169	206	243	280	319	319	355	355	391	428	428	465	502	539
Shade Pocket with Lip	132	169	206	243	280	319	319	355	355	391	428	428	465	502	539
Dual Shade Pocket (No Lip)	210	289	368	447	526	605	605	684	684	763	842	842	921	1000	1079
Closure Plate for Pocket	17	24	31	38	45	50	50	58	58	66	73	73	80	87	94
Hanger with Closure Plate	21	33	45	57	69	81	81	93	93	105	117	117	129	141	153
Inserted Fabric Valance	24	30	36	42	48	54	54	60	60	66	72	72	78	84	90
Ceiling "L" Fascia	51	70	89	108	127	146	146	165	165	184	203	203	222	241	260
Sill Channel	24	35	46	57	68	79	79	90	90	101	112	112	123	134	145
Cassette Commercial	100	140	180	220	260	300	300	340	340	N/A	N/A	N/A	N/A	N/A	N/A
Cassette Retail	63	82	101	120	139	158	158	177	177	N/A	N/A	N/A	N/A	N/A	N/A

Roller Shade Surcharge Options	
Stainless Steel Chain	\$12.00
White or Black Steel Chain	\$24.00
Platinum Clutch w/Steel Chain	\$10.00 NET
Rollease R-Series Clutch R8/R16/R24	\$0.00
External Aluminum Hembar	\$10.00
Wrapped Hembar	\$15.00
Spring Assisted Clutch	\$125.00
*Exterior Guide Wire System	\$200.00
Bottom-Up Shade w/Clutch	\$275.00
Multiple Band Motorized Shades	
1. Price each band separately and add together	
2. Price each coupler surcharge and add together	
3. Add shade band and coupler prices together	
Straight Line Coupler	\$100.00
90° Corner Coupler	\$200.00

* Stainless Steel Chain Required

Important Items To Note:

Screen fabrics will be fabricated vertically or horizontally (railroaded) at the factory's discretion or as noted on the price table above. Any shades wider and longer than the fabric's width will have one or more visible seams (splices).
The maximum warranted size of a clutch operated shade is 126" x 144".
Large Clutch shades may require a spring assisted lifting mechanism. Please refer to the manual clutch & tube matrix to determine if a spring assist is required.
Side channel surcharge includes left & right channels. Seal brushes available upon request.
Prices for valances, boxes, and pockets include all brackets and end caps.
Reverse roll option is not available for square, round, or wrapped fabric fascias.
The size of a shade will determine the size of the tube used; upgrades to larger tubes will be available upon request. Please refer to the manual/motorized clutch & tube matrix for specifics.
Shades exceeding a 3-to-1 ratio may have problems tracking. In other words, shades with a height dimension that is more than 3 times the width measurement may be susceptible to telescoping.
ALL MEASUREMENTS ARE BRACKET-TO-BRACKET

Shades up to 102" in width shipped via FedEx: \$4.00 / unit Net Freight Charge
Shades 102-8" to 125" in width shipped via FedEx: \$ 75.00 / unit Net Freight Charge
Shades 125 1/8" or greater in width shipped via Common Carrier: \$ 150.00 per shipment
Manufacturing specifications, options, surcharges and pricing are subject to change without notice.
Visit www.mariak.com for the most recent downloads.
All prices are in U.S. Dollars and do not include freight, duties or taxes for shipments to Alaska, Hawaii or Canada. GST and VAT are not included. Other restrictions and surcharges may apply. See Freight Policy for complete details.

Sun Control Roller Shades

SheerWeave Infinity-2 5% (Lead & PVC Free) 5% Open 98" Wide Fabric Poly-Olefin

Length	Width												Side Channels
	24	36	48	60	72	84	96	108	120	132	144	156	
36	198	251	307	357	461	532	561	712	1248	1360	1478	2017	70
48	218	277	337	399	510	591	621	986	1254	1372	1488	2027	93
60	238	307	376	440	554	654	761	991	1263	1378	1493	2035	116
72	257	331	407	480	607	710	824	994	1267	1385	1500	2040	139
84	275	360	442	525	656	773	882	1038	1603	1759	1902	2503	162
96	334	431	526	617	710	842	951	1478	1617	1780	1926	2533	185
108	357	459	561	661	758	901	1014	1484	1622	1788	1933	2543	208
120	399	496	596	704	812	961	1073	1490	1630	1800	1948	2555	231
132	465	579	688	810	929	1098	1135	1760	1929	2129	2310	2967	254
144	483	605	723	850	979	1159	1199	1765	1944	2139	2318	2976	277
156	556	704	850	1008	1164	1382	1439	1788	1968	2409	2610	3021	300

SheerWeave Infinity-2- Shades under the dashed line will be railroaded and have a visible seam

Fascia & Headbox Accessories

	Width											
	24	36	48	60	72	84	96	108	120	132	144	156
Additional Options:	24	36	48	60	72	84	96	108	120	132	144	156
3" & 4" Square Aluminum	45	55	65	75	85	95	105	115	125	135	145	155
3" & 4" Round Aluminum	45	55	65	75	85	95	105	115	125	135	145	155
3" & 4" Fabric Wrapped	89	110	131	152	173	194	215	236	257	278	299	320
Shade Pocket (No Lip)	132	169	206	243	280	319	355	391	428	465	502	539
Shade Pocket with Lip	132	169	206	243	280	319	355	391	428	465	502	539
Dual Shade Pocket (No Lip)	210	289	368	447	526	605	684	763	842	921	1000	1079
Closure Plate for Pocket	17	24	31	38	45	50	58	66	73	80	87	94
Hanger with Closure Plate	21	33	45	57	69	81	93	105	117	129	141	153
Inserted Fabric Valance	24	30	36	42	48	54	60	66	72	78	84	90
Ceiling "L" Fascia	51	70	89	108	127	146	165	184	203	222	241	260
Sill Channel	24	35	46	57	68	79	90	101	112	123	134	145
Cassette Commercial	100	140	180	220	260	300	340	N/A	N/A	N/A	N/A	N/A
Cassette Retail	63	82	101	120	139	158	177	N/A	N/A	N/A	N/A	N/A

Roller Shade Surcharge Options	
Stainless Steel Chain	\$12.00
White or Black Steel Chain	\$24.00
Platinum Clutch w/Steel Chain	\$10.00 NET
Rollease R-Series Clutch R8/R16/R24	\$0.00
External Aluminum Hembar	\$10.00
Wrapped Hembar	\$15.00
Spring Assisted Clutch	\$125.00
*Exterior Guide Wire System	\$200.00
Bottom-Up Shade w/Clutch	\$275.00
Multiple Band Motorized Shades	
1. Price each band separately and add together	
2. Price each coupler surcharge and add together	
3. Add shade band and coupler prices together	
Straight Line Coupler	\$100.00
90° Corner Coupler	\$200.00

Important Items To Note:	
Screen fabrics will be fabricated vertically or horizontally (railroaded) at the factory's discretion or as noted on the price table above. Any shades wider and longer than the fabric's width will have one or more visible seams (splices).	
The maximum warrantied size of a clutch operated shade is 126" x 144".	
Large Clutch shades may require a spring assisted lifting mechanism. Please refer to the manual clutch & tube matrix to determine if a spring assist is required.	
Side channel surcharge includes left & right channels. Seal brushes available upon request.	
Prices for valances, boxes, and pockets include all brackets and end caps.	
Reverse roll option is not available for square, round, or wrapped fabric fascias.	
The size of a shade will determine the size of the tube used; upgrades to larger tubes will be available upon request. Please refer to the manual/motorized clutch & tube matrix for specifics.	
Shades exceeding a 3-to-1 ratio may have problems tracking. In other words, shades with a height dimension that is more than 3 times the width measurement may be susceptible to telescoping.	
ALL MEASUREMENTS ARE BRACKET-TO-BRACKET	

* Stainless Steel Chain Required

Shades up to 102" in width shipped via FedEx: \$4.00 / unit Net Freight Charge
Shades 102-8" to 125" in width shipped via FedEx: \$ 75.00 / unit Net Freight Charge
Shades 125 1/8" or greater in width shipped via Common Carrier: \$ 150.00 per shipment
Manufacturing specifications, options, surcharges and pricing are subject to change without notice.
Visit www.mariak.com for the most recent downloads.
All prices are in U.S. Dollars and do not include freight, duties or taxes for shipments to Alaska, Hawaii or Canada. GST and VAT are not included. Other restrictions and surcharges may apply. See Freight Policy for complete details.

Sun Control Roller Shades

SheerWeave Infinity-2 3% (Lead & PVC Free) 3% Open 98" Wide Fabric Poly-Olefin

Length	Width												Side Channels
	24	36	48	60	72	84	96	108	120	132	144	156	
36	217	275	337	393	507	585	616	784	1373	1496	1625	2218	70
48	240	304	371	437	561	649	683	1083	1377	1508	1636	2231	93
60	262	337	413	484	609	719	837	1088	1389	1516	1643	2238	116
72	281	364	452	527	667	780	905	1092	1393	1523	1649	2244	139
84	302	395	486	576	721	850	970	1142	1763	1934	2090	2752	162
96	369	474	578	679	780	925	1046	1625	1779	1957	2117	2786	185
108	393	505	616	727	835	991	1114	1632	1783	1966	2126	2797	208
120	437	544	656	774	892	1057	1179	1638	1792	1979	2142	2811	231
132	511	636	756	890	1021	1207	1248	1937	2122	2343	2540	3263	254
144	531	665	794	934	1077	1276	1318	1942	2137	2353	2550	3273	277
156	612	774	934	1108	1280	1521	1582	1966	2165	2649	2870	3323	300

SheerWeave Infinity 2 - Shades under dashed line will be railroaded and have a visible seam

Fascia & Headbox Accessories

	Width											
	24	36	48	60	72	84	96	108	120	132	144	156
Additional Options:	24	36	48	60	72	84	96	108	120	132	144	156
3" & 4" Square Aluminum	45	55	65	75	85	95	105	115	125	135	145	155
3" & 4" Round Aluminum	45	55	65	75	85	95	105	115	125	135	145	155
3" & 4" Fabric Wrapped	89	110	131	152	173	194	215	236	257	278	299	320
Shade Pocket (No Lip)	132	169	206	243	280	319	355	391	428	465	502	539
Shade Pocket with Lip	132	169	206	243	280	319	355	391	428	465	502	539
Dual Shade Pocket (No Lip)	210	289	368	447	526	605	684	763	842	921	1000	1079
Closure Plate for Pocket	17	24	31	38	45	50	58	66	73	80	87	94
Hanger with Closure Plate	21	33	45	57	69	81	93	105	117	129	141	153
Inserted Fabric Valance	24	30	36	42	48	54	60	66	72	78	84	90
Ceiling "L" Fascia	51	70	89	108	127	146	165	184	203	222	241	260
Sill Channel	24	35	46	57	68	79	90	101	112	123	134	145
Cassette Commercial	100	140	180	220	260	300	340	N/A	N/A	N/A	N/A	N/A
Cassette Retail	63	82	101	120	139	158	177	N/A	N/A	N/A	N/A	N/A

Roller Shade Surcharge Options	Important Items To Note:
Stainless Steel Chain \$12.00	Screen fabrics will be fabricated vertically or horizontally (railroaded) at the factory's discretion or as noted on the price table above. Any shades wider and longer than the fabric's width will have one or more visible seams (splices).
White or Black Steel Chain \$24.00	
Platinum Clutch w/Steel Chain \$10.00 NET	The maximum warranted size of a clutch operated shade is 126" x 144".
Rollease R-Series Clutch R8/R16/R24 \$0.00	
External Aluminum Hembar \$10.00	Large Clutch shades may require a spring assisted lifting mechanism. Please refer to the manual clutch & tube matrix to determine if a spring assist is required.
Wrapped Hembar \$15.00	
Spring Assisted Clutch \$125.00	Side channel surcharge includes left & right channels. Seal brushes available upon request.
*Exterior Guide Wire System \$200.00	
Bottom-Up Shade w/Clutch \$275.00	Prices for valances, boxes, and pockets include all brackets and end caps.
Multiple Band Motorized Shades	Reverse roll option is not available for square, round, or wrapped fabric fascias.
1. Price each band separately and add together	The size of a shade will determine the size of the tube used; upgrades to larger tubes will be available upon request. Please refer to the manual/motorized clutch & tube matrix for specifics.
2. Price each coupler surcharge and add together	
3. Add shade band and coupler prices together	Shades exceeding a 3-to-1 ratio may have problems tracking. In other words, shades with a height dimension that is more than 3 times the width measurement may be susceptible to telescoping.
Straight Line Coupler \$100.00	
90° Corner Coupler \$200.00	***ALL MEASUREMENTS ARE BRACKET-TO-BRACKET***

* Stainless Steel Chain Required

Shades up to 102" in width shipped via FedEx: \$4.00 / unit Net Freight Charge
Shades 102-1/8" to 125" in width shipped via FedEx: \$ 75.00 / unit Net Freight Charge
Shades 125 1/8" or greater in width shipped via Common Carrier: \$ 150.00 per shipment
Manufacturing specifications, options, surcharges and pricing are subject to change without notice.
Visit www.mariak.com for the most recent downloads.
All prices are in U.S. Dollars and do not include freight, duties or taxes for shipments to Alaska, Hawaii or Canada. GST and VAT are not included. Other restrictions and surcharges may apply. See Freight Policy for complete details.

Sun Control Roller Shades

Vizela (Lead & PVC Free) 78" Wide Fabric Fiberglass/EVA

Length	Width													Side Channels
	24	36	48	60	72	76	78	96	108	120	132	144	156	
36	217	275	337	393	507	585	616	616	784	1373	1496	1625	2218	70
48	240	304	371	437	561	649	683	683	1083	1377	1508	1636	2231	93
60	262	337	413	484	609	719	837	837	1088	1389	1516	1643	2238	116
72	281	364	452	527	667	780	905	910	1092	1393	1523	1649	2244	139
76	302	395	486	576	721	850	970	970	1142	1763	1934	2090	2752	162
84	302	395	486	576	721	850	970	970	1142	1763	1934	2090	2752	162
96	369	474	578	679	780	925	1046	1046	1625	1779	1957	2117	2786	185
108	393	505	616	727	835	991	1114	1114	1632	1783	1966	2126	2797	208
120	437	544	656	774	892	1057	1179	1179	1638	1792	1979	2142	2811	231
132	511	636	756	890	1021	1207	1248	1248	1937	2122	2343	2540	3263	254
144	531	665	794	934	1077	1276	1318	1318	1942	2137	2353	2550	3273	277
156	612	774	934	1108	1280	1521	1582	1582	1966	2165	2649	2870	3323	300

Vizela - Shades under the dashed line will be railroaded and have a visible seam

Fascia & Headbox Accessories

	Width												
Additional Options:	24	36	48	60	72	77	84	96	108	120	132	144	156
3" & 4" Square Aluminum	45	55	65	75	85	95	95	105	115	125	135	145	155
3" & 4" Round Aluminum	45	55	65	75	85	95	95	105	115	125	135	145	155
3" & 4" Fabric Wrapped	89	110	131	152	173	194	194	215	236	257	278	299	320
Shade Pocket (No Lip)	132	169	206	243	280	319	319	355	391	428	465	502	539
Shade Pocket with Lip	132	169	206	243	280	319	319	355	391	428	465	502	539
Dual Shade Pocket (No Lip)	210	289	368	447	526	605	605	684	763	842	921	1000	1079
Closure Plate for Pocket	17	24	31	38	45	50	50	58	66	73	80	87	94
Hanger with Closure Plate	21	33	45	57	69	81	81	93	105	117	129	141	153
Inserted Fabric Valance	24	30	36	42	48	54	54	60	66	72	78	84	90
Ceiling "L" Fascia	51	70	89	108	127	146	146	165	184	203	222	241	260
Sill Channel	24	35	46	57	68	79	79	90	101	112	123	134	145
Cassette Commercial	100	140	180	220	260	300	300	340	N/A	N/A	N/A	N/A	N/A
Cassette Retail	63	82	101	120	139	158	158	177	N/A	N/A	N/A	N/A	N/A

Roller Shade Surcharge Options	
Stainless Steel Chain	\$12.00
White or Black Steel Chain	\$24.00
Platinum Clutch w/Steel Chain	\$10.00 NET
Rollease R-Series Clutch R8/R16/R24	\$0.00
External Aluminum Hembar	\$10.00
Wrapped Hembar	\$15.00
Spring Assisted Clutch	\$125.00
*Exterior Guide Wire System	\$200.00
Bottom-Up Shade w/Clutch	\$275.00
Multiple Band Motorized Shades	
1. Price each band separately and add together	
2. Price each coupler surcharge and add together	
3. Add shade band and coupler prices together	
Straight Line Coupler	\$100.00
90° Corner Coupler	\$200.00

* Stainless Steel Chain Required

Important Items To Note:

Screen fabrics will be fabricated vertically or horizontally (railroaded) at the factory's discretion or as noted on the price table above. Any shades wider and longer than the fabric's width will have one or more visible seams (splices).
The maximum warranted size of a clutch operated shade is 126" x 144".
Large Clutch shades may require a spring assisted lifting mechanism. Please refer to the manual clutch & tube matrix to determine if a spring assist is required.
Side channel surcharge includes left & right channels. Seal brushes available upon request.
Prices for valances, boxes, and pockets include all brackets and end caps.
Reverse roll option is not available for square, round, or wrapped fabric fascias.
The size of a shade will determine the size of the tube used; upgrades to larger tubes will be available upon request. Please refer to the manual/motorized clutch & tube matrix for specifics.
Shades exceeding a 3-to-1 ratio may have problems tracking. In other words, shades with a height dimension that is more than 3 times the width measurement may be susceptible to telescoping.
ALL MEASUREMENTS ARE BRACKET-TO-BRACKET

Shades up to 102" in width shipped via FedEx: \$4.00 / unit Net Freight Charge
Shades 102-1/8" to 125" in width shipped via FedEx: \$ 75.00 / unit Net Freight Charge
Shades 125 1/8" or greater in width shipped via Common Carrier: \$ 150.00 per shipment
Manufacturing specifications, options, surcharges and pricing are subject to change without notice.
Visit www.mariak.com for the most recent downloads.
All prices are in U.S. Dollars and do not include freight, duties or taxes for shipments to Alaska, Hawaii or Canada. GST and VAT are not included. Other restrictions and surcharges may apply. See Freight Policy for complete details.

Sun Control Roller Shades

Flocke Blackout (Lead & PVC Free)	0% Open	78" Wide Fabric	Fiberglass/Acrylic
SheerWeave Performance+ 5% 2390 (Energy Saving & Lead Free)	5% Open	96" Wide Fabric	Metallized Fiberglass/PVC

Indicate full fabric name when ordering SW2390 5% Performance+

		Width													Side Channels	
		24	36	48	60	72	76	84	94	96	108	120	132	144		156
Length	36	257	325	400	464	598	691	691	728	728	926	1623	1767	1921	2621	70
	48	283	360	438	518	662	768	768	808	808	1281	1629	1783	1934	2637	93
	60	309	400	488	574	721	850	850	990	990	1286	1642	1792	1942	2645	116
	72	333	431	528	623	789	923	923	1072	1072	1290	1647	1800	1950	2651	139
	76	357	467	576	682	852	1005	1005	1147	1147	1348	2085	2287	2472	3253	162
	84	357	467	576	682	852	1005	1005	1147	1147	1348	2085	2287	2472	3253	162
	94	435	561	683	801	923	1096	1096	1236	1236	1921	2102	2313	2503	3292	185
	96	435	561	683	801	923	1096	1096	1236	1236	1921	2102	2313	2503	3292	185
	108	464	595	728	860	986	1170	1170	1319	1319	1928	2109	2324	2513	3306	208
	120	518	643	776	914	1055	1251	1251	1394	1394	1937	2119	2339	2532	3322	231
	132	605	752	895	1053	1208	1213	1213	1477	1477	2288	2507	2768	3003	3857	254
	144	629	787	940	1105	1274	1506	1506	1557	1557	2294	2527	2780	3013	3868	277
156	724	914	1105	1310	1513	1797	1797	1869	1869	2324	2558	3132	3393	3926	300	

Flocke - Shades under the double line will be railroaded and have a visible seam

SheerWeave Performance+ - Shades under the dashed line will be railroaded and have a visible seam

Fascia & Headbox Accessories

		Width													
		24	36	48	60	72	76	84	94	96	108	120	132	144	156
Additional Options:		24	36	48	60	72	76	84	94	96	108	120	132	144	156
3" & 4" Square Aluminum		45	55	65	75	85	95	95	105	105	115	125	135	145	155
3" & 4" Round Aluminum		45	55	65	75	85	95	95	105	105	115	125	135	145	155
3" & 4" Fabric Wrapped		89	110	131	152	173	194	194	215	215	236	257	278	299	320
Shade Pocket (No Lip)		132	169	206	243	280	319	319	355	355	391	428	465	502	539
Shade Pocket with Lip		132	169	206	243	280	319	319	355	355	391	428	465	502	539
Dual Shade Pocket (No Lip)		210	289	368	447	526	605	605	684	684	763	842	921	1000	1079
Closure Plate for Pocket		17	24	31	38	45	50	50	58	58	66	73	80	87	94
Hanger with Closure Plate		21	33	45	57	69	81	81	93	93	105	117	129	141	153
Inserted Fabric Valance		24	30	36	42	48	54	54	60	60	66	72	78	84	90
Ceiling "L" Fascia		51	70	89	108	127	146	146	165	165	184	203	222	241	260
Sill Channel		24	35	46	57	68	79	79	90	90	101	112	123	134	145
Cassette Commercial		100	140	180	220	260	300	300	340	340	N/A	N/A	N/A	N/A	N/A
Cassette Retail		63	82	101	120	139	158	158	177	177	N/A	N/A	N/A	N/A	N/A

Roller Shade Surcharge Options	
Stainless Steel Chain	\$12.00
White or Black Steel Chain	\$24.00
Platinum Clutch w/Steel Chain	\$10.00 NET
Rollease R-Series Clutch R8/R16/R24	\$0.00
External Aluminum Hembar	\$10.00
Wrapped Hembar	\$15.00
Spring Assisted Clutch	\$125.00
*Exterior Guide Wire System	\$200.00
Bottom-Up Shade w/Clutch	\$275.00
Multiple Band Motorized Shades	
1. Price each band separately and add together	
2. Price each coupler surcharge and add together	
3. Add shade band and coupler prices together	
Straight Line Coupler	\$100.00
90° Corner Coupler	\$200.00

* Stainless Steel Chain Required

Important Items To Note:

Screen fabrics will be fabricated vertically or horizontally (railroaded) at the factory's discretion or as noted on the price table above. Any shades wider and longer than the fabric's width will have one or more visible seams (splices).

The maximum warranted size of a clutch operated shade is 126" x 144".

Large Clutch shades may require a spring assisted lifting mechanism. Please refer to the manual clutch & tube matrix to determine if a spring assist is required.

Side channel surcharge includes left & right channels. Seal brushes available upon request.

Prices for valances, boxes, and pockets include all brackets and end caps.

Reverse roll option is not available for square, round, or wrapped fabric fascias.

The size of a shade will determine the size of the tube used; upgrades to larger tubes will be available upon request. Please refer to the manual/motorized clutch & tube matrix for specifics.

Shades exceeding a 3-to-1 ratio may have problems tracking. In other words, shades with a height dimension that is more than 3 times the width measurement may be susceptible to telescoping.

ALL MEASUREMENTS ARE BRACKET-TO-BRACKET

Shades up to 102" in width shipped via FedEx: \$4.00 / unit Net Freight Charge
Shades 102-8" to 125" in width shipped via FedEx: \$ 75.00 / unit Net Freight Charge
Shades 125 1/8" or greater in width shipped via Common Carrier: \$ 150.00 per shipment
Manufacturing specifications, options, surcharges and pricing are subject to change without notice.
Visit www.mariak.com for the most recent downloads.
All prices are in U.S. Dollars and do not include freight, duties or taxes for shipments to Alaska, Hawaii or Canada. GST and VAT are not included. Other restrictions and surcharges may apply. See Freight Policy for complete details.

Sun Control Roller Shades

SheerWeave Performance+ 3% 2410 (Energy Saving & Lead Free) 3% Open 96" Wide Fabric Metallized Fiberglass/PVC

Indicate full fabric name when ordering SW2410 3% Performance+

Length	Width													Side Channels
	24	36	48	60	72	76	84	96	108	120	132	144	156	
36	281	357	438	511	658	760	760	800	1018	1785	1944	2113	2882	70
48	311	395	482	569	728	844	844	888	1409	1791	1962	2126	2900	93
60	340	438	537	630	795	934	934	1086	1415	1805	1970	2136	2908	116
72	366	473	580	685	867	1018	1018	1177	1420	1811	1979	2144	2918	139
76	392	514	633	748	936	1105	1105	1261	1484	2292	2514	2717	3577	162
84	392	514	633	748	936	1105	1105	1261	1484	2292	2514	2717	3577	162
96	479	615	751	881	1014	1203	1203	1360	2113	2312	2543	2752	3621	185
108	511	655	800	945	1084	1287	1287	1448	2121	2318	2555	2764	3636	208
120	569	708	852	1006	1159	1374	1374	1533	2129	2329	2573	2784	3653	231
132	665	827	983	1157	1328	1568	1568	1623	2517	2758	3045	3302	4241	254
144	690	864	1031	1214	1399	1657	1657	1712	2524	2778	3059	3314	4255	277
156	795	1006	1214	1440	1663	1975	1975	2058	2555	2813	3444	3731	4319	300

SheerWeave Performance+ - Shades under the dashed line will be railroded and have a visible seam

Fascia & Headbox Accessories

	Width												
	24	36	48	60	72	76	84	96	108	120	132	144	156
Additional Options:	24	36	48	60	72	76	84	96	108	120	132	144	156
3" & 4" Square Aluminum	45	55	65	75	85	95	95	105	115	125	135	145	155
3" & 4" Round Aluminum	45	55	65	75	85	95	95	105	115	125	135	145	155
3" & 4" Fabric Wrapped	89	110	131	152	173	194	194	215	236	257	278	299	320
Shade Pocket (No Lip)	132	169	206	243	280	319	319	355	391	428	465	502	539
Shade Pocket with Lip	132	169	206	243	280	319	319	355	391	428	465	502	539
Dual Shade Pocket (No Lip)	210	289	368	447	526	605	605	684	763	842	921	1000	1079
Closure Plate for Pocket	17	24	31	38	45	50	50	58	66	73	80	87	94
Hanger with Closure Plate	21	33	45	57	69	81	81	93	105	117	129	141	153
Inserted Fabric Valance	24	30	36	42	48	54	54	60	66	72	78	84	90
Ceiling "L" Fascia	51	70	89	108	127	146	146	165	184	203	222	241	260
Sill Channel	24	35	46	57	68	79	79	90	101	112	123	134	145
Cassette Commercial	100	140	180	220	260	300	300	340	N/A	N/A	N/A	N/A	N/A
Cassette Retail	63	82	101	120	139	158	158	177	N/A	N/A	N/A	N/A	N/A

Roller Shade Surcharge Options	
Stainless Steel Chain	\$12.00
White or Black Steel Chain	\$24.00
Platinum Clutch w/Steel Chain	\$10.00 NET
Rollease R-Series Clutch R8/R16/R24	\$0.00
External Aluminum Hembar	\$10.00
Wrapped Hembar	\$15.00
Spring Assisted Clutch	\$125.00
*Exterior Guide Wire System	\$200.00
Bottom-Up Shade w/Clutch	\$275.00
Multiple Band Motorized Shades	
1. Price each band separately and add together	
2. Price each coupler surcharge and add together	
3. Add shade band and coupler prices together	
Straight Line Coupler	\$100.00
90° Corner Coupler	\$200.00

* Stainless Steel Chain Required

Important Items To Note:

Screen fabrics will be fabricated vertically or horizontally (railroded) at the factory's discretion or as noted on the price table above. Any shades wider and longer than the fabric's width will have one or more visible seams (splices).

The maximum warranted size of a clutch operated shade is 126" x 144".

Large Clutch shades may require a spring assisted lifting mechanism. Please refer to the manual clutch & tube matrix to determine if a spring assist is required.

Side channel surcharge includes left & right channels. Seal brushes available upon request.

Prices for valances, boxes, and pockets include all brackets and end caps.

Reverse roll option is not available for square, round, or wrapped fabric fascias.

The size of a shade will determine the size of the tube used; upgrades to larger tubes will be available upon request. Please refer to the manual/motorized clutch & tube matrix for specifics.

Shades exceeding a 3-to-1 ratio may have problems tracking. In other words, shades with a height dimension that is more than 3 times the width measurement may be susceptible to telescoping.

ALL MEASUREMENTS ARE BRACKET-TO-BRACKET

Shades up to 102" in width shipped via FedEx: \$4.00 / unit Net Freight Charge
Shades 102-1/8" to 125" in width shipped via FedEx: \$ 75.00 / unit Net Freight Charge
Shades 125 1/8" or greater in width shipped via Common Carrier: \$ 150.00 per shipment
Manufacturing specifications, options, surcharges and pricing are subject to change without notice.
Visit www.mariak.com for the most recent downloads.
All prices are in U.S. Dollars and do not include freight, duties or taxes for shipments to Alaska, Hawaii or Canada. GST and VAT are not included. Other restrictions and surcharges may apply. See Freight Policy for complete details.

Purchase Order Roller Shades

Account #: _____ Company Name: _____ Contact: _____ Page _____ of _____
 Ship To Address: _____ Phone: _____ Purchase Order #: _____
 City: _____ State: _____ Zip: _____ Fax: _____ Date Required: _____
 EMAIL: _____ Ship Via (circle one): FedEX Common Carrier Mariak Truck Will Call

Line	Sidemark	Qty	Mount ¹	Width	Length	Fabric Type ²	Fabric Color ³	*Image Printing Yes/No	Lift Type ⁴	**Programming Yes or No	Spring Assist ⁵	Lift Side ⁶	Control Length ⁷	Fabric Roll ⁸	Hembar Type ⁹	Valance ¹⁰	Channels ¹¹		
																	Side	Sill	Color
1																			
2																			
3																			
4																			
5																			
6																			
7																			
8																			
9																			
10																			

* Please complete and submit Mariak's Image Printing Purchase Order Form to mariagraphics@mariak.com

** Programming note if intermediate stops required to be measured from the top of the shade:

Position #1: _____ Position #2: _____ Position #3: _____

Purchase Order Footnotes:

1. Mount:	(IM) - Inside Mount (OM) - Outside Mount
2. Fabric Type:	Specify the type of material.
3. Fabric Color:	Specify the color # and name.
4. Lift Type:	(CHN-PL) - Chain Operated Clutch with Plastic Chain (CHN-SS) - Chain Operated Clutch with Stainless Steel Chain (CHN-WSS) - Chain Operated Clutch w/ WHT SS Chain (CHN-BSS) - Chain Operated Clutch w/ BLK SS Chain (SPR) - Spring Operated (CHN-PLT-WMT) - Chain Operated Platinum Clutch w/ SS Chain Wall Mount Bracket (CHN-PLT-CMT) - Chain Operated Platinum Clutch w/ SS Chain Ceiling Mount Bracket (CHN-RLS) - Chain Operated R8/R16/R24 Clutch (RS E-MOTOR-RF) Econoline Motor (MTR-BAT-RTS) - Somfy LT30 RTS Battery Powered Motor (MTR-DC-RTS) - Somfy ST30 RTS DC Powered Motor (MTR-AC-RTS) - Somfy ST50 or LT50 RTS AC Powered Motor (MTR-AC-HW) - Standard Hardwired 4-Wire AC Powered Motor (MRT-ILT) - Somfy iLT Intelligent Motor

5. Spring Assist:	Please see Manual Clutch & Tube Matrix for Spring Assist Requirements.
6. Lift Side:	(L) - Left Side Lift (R) - Right Side Lift
7. Control Length:	If desired, the control length may be specified. Standard Chain Length = 75% of the Shade Drop Minimum Chain Length = 67% of the Shade Drop Standard AC Motor Cable Length = 6 Ft. / May be ordered up to 24 Ft. for an additional charge

8. Fabric Roll:	(R) - Regular Roll (Standard - Fabric rolls off the back of the roller tube - Closest to the Glass) (V) - Reverse Roll (Optional - Fabric rolls off the front of the roller tube - Away from the Glass)
9. Hembar Type:	(PKT) - Pocket Hembar (3-Side Welded) (EXT) - External Hembar (Alabaster, Anodized, Black, Bronze, White) (WH) - Wrapped Hembar (Fabric covered front, exposed aluminum on back)
10. Valance:	(3"SQR) - 3" Square Fascia (ALB, AND, BLK, BRZ, WHT) (4"SQR) - 4" Square Fascia (ALB, AND, BLK, BRZ, WHT) (3"RND) - 3" Round Fascia (AND, BLK, WHT) (4"RND) - 4" Round Fascia (AND, BLK, WHT) (3"FAB) - 3" Fabric Wrapped Fascia (AND, BLK, WHT) (4"FAB) - 4" Fabric Wrapped Fascia (AND, BLK, WHT) (PKT-NO-LIP) - Shade Pocket without Lip (AND, WHT) (PKT-LIP) - Shade Pocket with Lip (AND, WHT) (HNGR) - Mount Hanger with Closure Plate (AND, BLK, WHT) (CASSR) - Cassette Residential w/fabric insert (ANO, ALA, BLK, BRZ, WHT) (CASSC) - Cassette Commercial w/fascia (ANO, ALA, BLK, BRZ, WHT) (INS) - Inserted Fabric Valance
11. Channels:	Specify side and/or sill channels if desired. (Alabaster, Anodized, Black, Bronze, White)

Motor Control Options:

If RTS motors are selected, specify the required controls.	
Radio Frequency (RTS) Controls:	Quantity
1 Ch. - RTS Hand Held Transmitter	
5 Ch. - RTS Hand Held Transmitter	
20 Ch. - RTS Hand Held Transmitter	
1 Ch. - RTS Wireless Wall Switch	
5 Ch. - RTS Wireless Wall Switch	
RS E-TRIM-1CH Transmitter Econoline	
RS E-TRIM -6CH Transmitter Econoline	
RS E-TRIM-16CH Transmitter Econoline	
RTS 24 - Hour Timer	
RTS Sun Sensor	
16 Ch. - RTS Interface for Automation Integration	
If Standard 4-wire motors are selected, specify the required controls.	
Standard Controls:	Quantity
SPDT Paddle Wall Switch	
DPDT Pall Wall Switch	
GCS II 4-Motor Controller	
IGC Single Motor Controller	
IGC3N1 3 Motor Controller	
IGC Standard Wall Switch	

11.26.13kb

ALL MEASUREMENTS ARE BRACKET-TO-BRACKET

PLEASE SPECIFY FULL FABRIC NAME/PERCENTAGE/COLOR NAME & COLOR NUMBER

Consult Mariak Technical Support for Additional Options

Imaging Printing Purchase Order Form

Account #	
Company Name:	
Contact:	
Ship To Address:	
City:	
State:	
Zip:	
Image Submitted Via:	Email
	CD-ROM/Flash Drive
Line Item Number:	Shade Size:
Line Item Number:	Shade Size:
Line Item Number:	Shade Size:
Line Item Number:	Shade Size:

Contact:		
Phone:		
Fax:		
Email:		
Sidemark:		
Purchase Order #:		
Sales Order:		
Ship Via (Circle One):	<input type="checkbox"/> Mariak Truck	<input type="checkbox"/> Will Call
	<input type="checkbox"/> FedEx	<input type="checkbox"/> Common Carrier

Please indicate selections below by circling.										
Print Ready:	<input type="checkbox"/> Yes	<input type="checkbox"/> No	Please Mark One							
File Type:	<input type="checkbox"/> EPS	<input type="checkbox"/> AI		<input type="checkbox"/> PDF	<input type="checkbox"/> RAW	<input type="checkbox"/> TIFF	<input type="checkbox"/> JPED	<input type="checkbox"/> PSD	Placement:	
Graphic Type:	<input type="checkbox"/> Image	<input type="checkbox"/> Logo	<input type="checkbox"/> Graphic	<input type="checkbox"/> Solid Color					<input type="checkbox"/> Centered	
Print Side:	<input type="checkbox"/> Street Side		<input type="checkbox"/> Inside						<input type="checkbox"/> Justified	
Double Sided Printing:	<input type="checkbox"/> Yes		<input type="checkbox"/> No						<input type="checkbox"/> Centered Bottom	
Landscape Printing:	<input type="checkbox"/> Yes		<input type="checkbox"/> No						<input type="checkbox"/> Full Bleed	
Valance Insert:	<input type="checkbox"/> Yes		<input type="checkbox"/> No						<input type="checkbox"/> Other	

Print Ready Set-Up Fee	\$25.00 Net
Non-Print Ready Set-Up Fee	\$50.00 Net
Image, Graphic or Logo Image Cost	*\$4.00 Net Per Sq. Ft.
Solid Color Covering Entire Shade	50% Net Surcharge
Landscape Image Printing	50% Net Surcharge
Underlay for darker fabrics	\$2.00 Net Per Sq. Ft.
Insert for Fabric Wrapped Fascia	\$10.00 Net Per Shade
Sample Fee 8-1/2" x 11"	\$15.00 Net Per Sample
<small>* Square foot is measured from outer point of image including any blank or unused space contained within the image \$40.00 Minimum applies.</small>	
Samples Requested:	

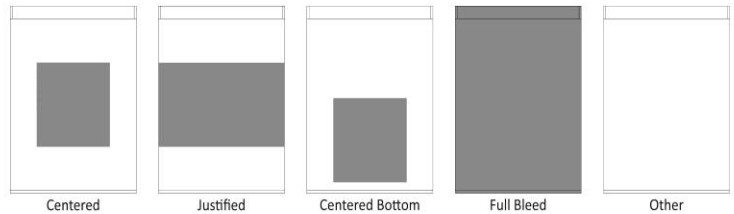

Please sketch image and dimensions in this space.		
	SHADE LENGTH _____	
	IMAGE LENGTH _____	
		IMAGE WIDTH _____
		SHADE WIDTH _____

All image printing shall be subject to verification or appropriate copyright ownership/licensure and execution of "Mariak's custom Printing Agreement".
 Image printed shades are backed by a 5-Year Limited Warranty. Please see "Mariak's Image Printed Roller Shade Limited Warranty" for details.

Special Instructions:

Mariak

BLANK PAGE

575 West Manville Street
Rancho Dominguez, CA 90220
(800) 562-7425 Fax: (800) 459-6999
www.mariak.com