

3" and 4" Square Aluminum Fascia Valance:

These "L"-shaped aluminum extrusions cover the front and bottom of the roller. Valances lock to brackets by means of snap-in fittings. The roller is concealed behind the valance and the bottom of the shade drops from the back of the valance when lowered.

Roll: Available for regular roll only
 Color: Alabaster, Black, Bronze, Clear Anodized & White
 Mount: Inside or Outside
 Clutch: M16 (3"), M24 (4")
 Motor: DC (3" or 4"), AC (4" only)
 Minimum Width: 18"
 Maximum Width: 240"

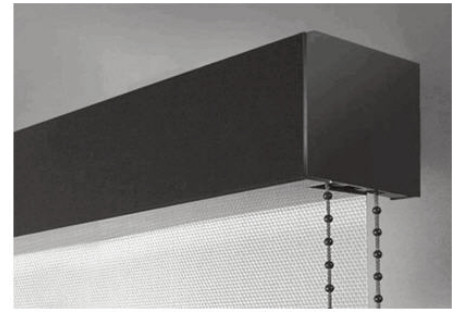
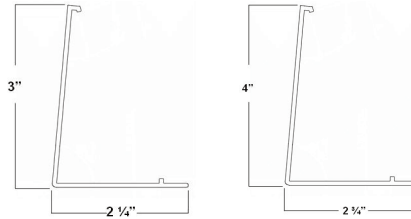

3" and 4" Round Aluminum Fascia Valance:

These aluminum extrusions offer a contoured appearance, softer than traditional square fascias. Valances cover the front and bottom of the roller and lock to its brackets by means of snap-in fittings. The roller is concealed behind this valance and the bottom of the shade drops from the back of the valance when lowered.

Roll: Available for regular roll only
 Color: Black, Clear Anodized & White
 Mount: Inside or Outside
 Clutch: M16 (3"), M24 (4")
 Motor: DC (3" or 4"), AC (4" only)
 Minimum Width: 18"
 Maximum Width: 240"

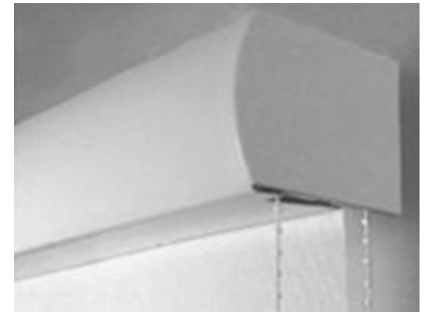
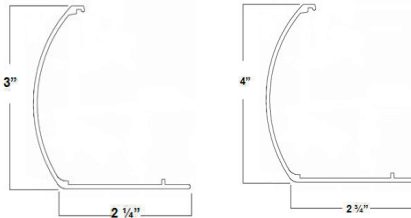

3" and 4" Fabric Wrapped Fascia Valance:

These Round Aluminum Fascia Valances include fabric matching the Roller Shade wrapped around the aluminum extrusion. Valances cover the front and bottom of the roller and lock to its brackets by means of snap-in fittings. The roller is concealed behind the valance and the bottom of the shade drops from the back of the valance when lowered.

Roll: Available for regular roll only
 Color: Valance fabric matches shade
 Mount: Inside or Outside (Outside Recommended)
 Clutch: M16 (3"), M24 (4")
 Motor: DC (3" or 4"), AC (4" only)
 Minimum Width: 18"
 Maximum Width: 240"

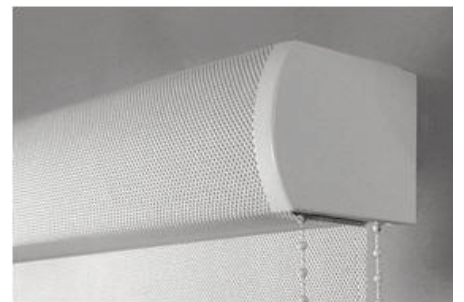
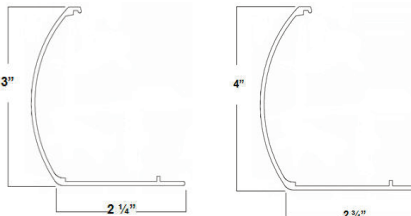

4" and 7 1/2" Dual Square Fascia:

For applications where both Sunscreen and Room Darkening shades are required, the 4" and 7 1/2" Square Aluminum Fascia Valances offer a solution. These "L"-shaped aluminum extrusions cover the front and bottom of the front-most Roller Shade. These valance accessories lock to their brackets by means of snap-in fittings. The front roller is concealed behind the valance and the bottom of the shade drops from the back of the valance when lowered.

Roll: Available for regular roll only
 Color: Alabaster, Black, Bronze, Clear Anodized & White
 Mount: Inside or Outside
 Clutch: M16 (4")
 Sunscreen Shade (Front) M24 & Room Darkening Shade (Back) (7 1/2")
 Motor: DC (4"), AC or DC (7 1/2")
 Control: Right/Right or Left/Left Chain Controls
 Minimum Width: 18"
 Maximum Width: 240"
 Bracket Dimensions: 4" Height x 5 3/4" Depth; 7 1/2" Height x 5 3/4" Depth

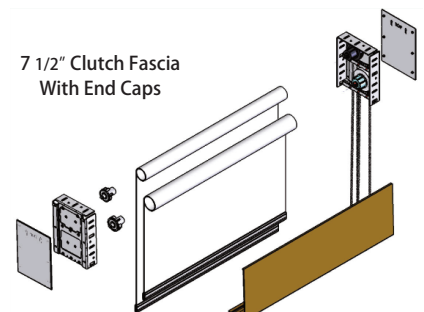
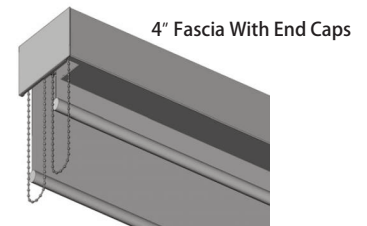

Mariak Commercial Shade Cassette:

Flat front fascia blends with internal structural shapes of commercial buildings, offering aesthetically pleasing, easy to maintain closure for Roller Shades. Snap-on brackets provide quick and easy on-site installation. Commercial quality clutch can be placed on either side of the cassette. Height-adjustable idler end allows level correction without need for shims. Cassette size 3 1/8" by 4" easily fits inside typical window openings.

Roll:	Available for regular roll only	Tube:	1 1/2" Tube up to 96" wide
Color:	Anodized, Alabaster, Black, Bronze or White	Min. Width:	20" Min. Length: 20"
Mount:	Inside or Outside	Max. Width:	114" Max. Length: 120"
Clutch:	CS Clutch 16 lb.		
Idle Side:	Adjustable height position		
Motor:	DC		
Control:	Right or Left		

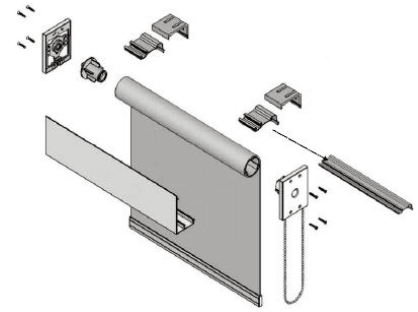

Mariak Residential Roller Shade Cassette:

For applications requiring elegant contemporary looks, Mariak Industries Inc. offers a cassette. The aluminum 3 1/2" by 3 1/2" extrusion provides space for roll of fabric up to 3 inches in diameter. Snap-on mounting brackets allow for quick installation. Front of the cassette can be finished with the shade fabric. Internal brackets allow the cassette to be used with 15 lb. clutch or DC motor.

Roll:	Available for regular roll or reversed roll
Color:	Anodized, Alabaster, Black, Bronze or White
Mount:	Inside or Outside
Clutch:	SL 15
Motor:	DC
Min. Width:	20" Min. Length: 20"
Max. Width:	96" Max. Length: 120"



LEVEL CORRECT BRACKET™ For Fascia:

The LEVEL CORRECT BRACKET™ allows installers to level the Roller Shade without removing and re-installing brackets. By removing a small allen wrench that is provided on the inside of each bracket, installers can raise or lower the idler pin end of the Roller Shade with a simple turn of a basic set screw located at the bottom opening of the fascia bracket. This bracket is available with clutch operated or motorized shades ordered with 3" or 4" fascia valances.

Bracket Dimensions:	Ceiling Mount Installation		Wall Mount Installation	
Clutch & Bracket Used	Projection	Height	Projection	Height
3" Fascia M-Series Bracket	3"	3"	3"	3"
4" Fascia M-Series Bracket	4"	4"	4"	4"

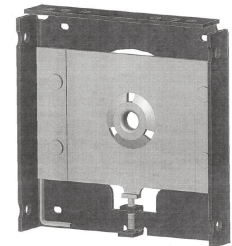

Standard Non-Fascia Bracket:

Bracket Dimensions:	Ceiling Mount Installation		Wall Mount Installation	
Clutch & Bracket Used	Projection	Height	Projection	Height
1 1/4" M8 Clutch Bracket	1 7/8"	2 3/8"	2 3/8"	1 7/8"
1 1/2" M16 Clutch Bracket	2 7/8"	2 5/8"	2 5/8"	2 7/8"
1 3/4" M24 Clutch Bracket	3 1/4"	3"	3"	3 1/4"

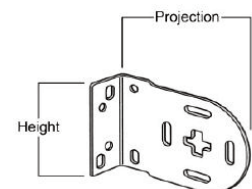

Bracket Shown as used in
Wall Mount Installation

7" Dual Shade Brackets:

Bracket Dimensions:
Width: 5"
Height: 7 1/2"

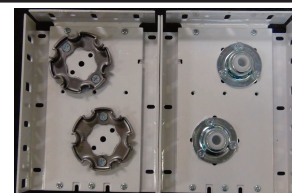

Motor Dual Brackets

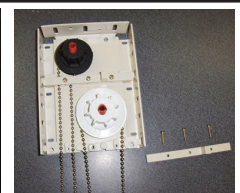

Manual Bracket

Standard Motor Brackets:

Bracket Dimensions:	Ceiling Mount Installation		Wall Mount Installation	
Clutch & Bracket Used	Projection	Height	Projection	Height
Standard Motor Bracket	2 1/2"	2 7/8"	2 7/8"	2 1/2"
Fascia Motor Bracket	4"	4"	4"	4"

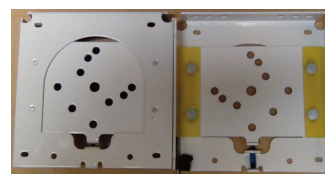

Fascia Motor Bracket

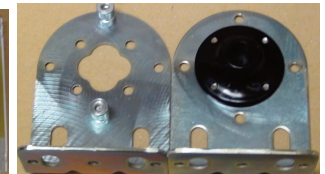

Standard Non-Fascia Motor Bracket