

Mariak

Many Window Solutions From One Source

West Lake Woven Wood Shade Section

Effective August 10, 2011



Save a life: "Install Safety Tension Devices!"

Mariak

Many Window Solutions From One Source

Woven Wood Measuring Instructions

Measuring Inside Mount (IB) Shades:

Measure the exact width (A) and length (B) of the window opening as shown. The factory will deduct ½" overall from the window width for clearance. On all inside mount shades, a small light gap will be visible.

Measuring Outside Mount (OB) Shades:

Measure the exact width (A) and length (B) of the window opening you wish to cover. The shade should cover the window opening by at least 2" on both the width and length. To cover a window sill, provide a measurement (C) beyond the sill.

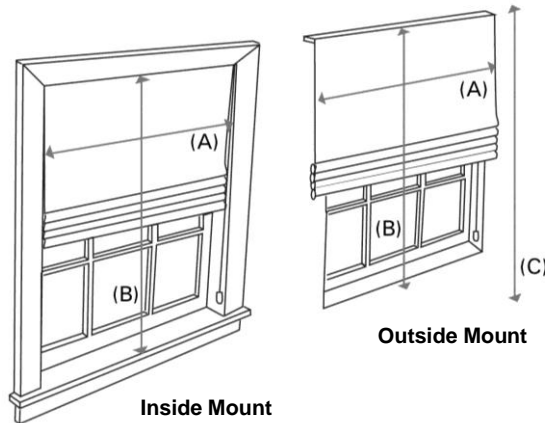

Measuring Arch Top Valances for Woven Wood Shades:

For inside mount shades, measure the exact width and tallest length inside the window opening. For outside mount shades, measure the desired width and tallest length. Make sure to measure the length of outside mount shades at its tallest point. Arch Top woven wood shades must be perfect arches where the length equals ½ the width. For arch top valances, measure dimensions A, X, & Y. For pricing, use the width and tallest length measurement. Make sure to add the arch top shade surcharge.

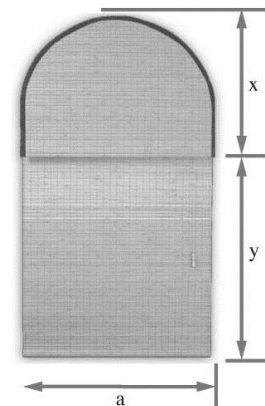

Arch Top

Measuring Angled Shades:

It is critical to measure all four sides of the window opening. For inside mount shades, measure the inside of the window opening and for outside mount shades, add the desired overlap. Measure the slope angle with a protractor and provide the angle in degrees. Indicate all measurements on a template to be sent to the factory. For pricing, use the tallest length of the shade. For angle top valances, measure dimensions A, X, & Y. For pricing, use the width and tallest length measurement. Make sure to add the angled shade surcharge.

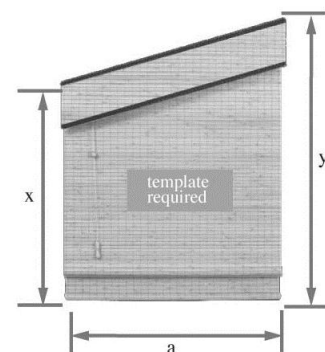

Angle Top with Angled Valance

Mariak

Many Window Solutions From One Source

Woven Wood Exploded Diagram

Standard Style Woven Wood Shade

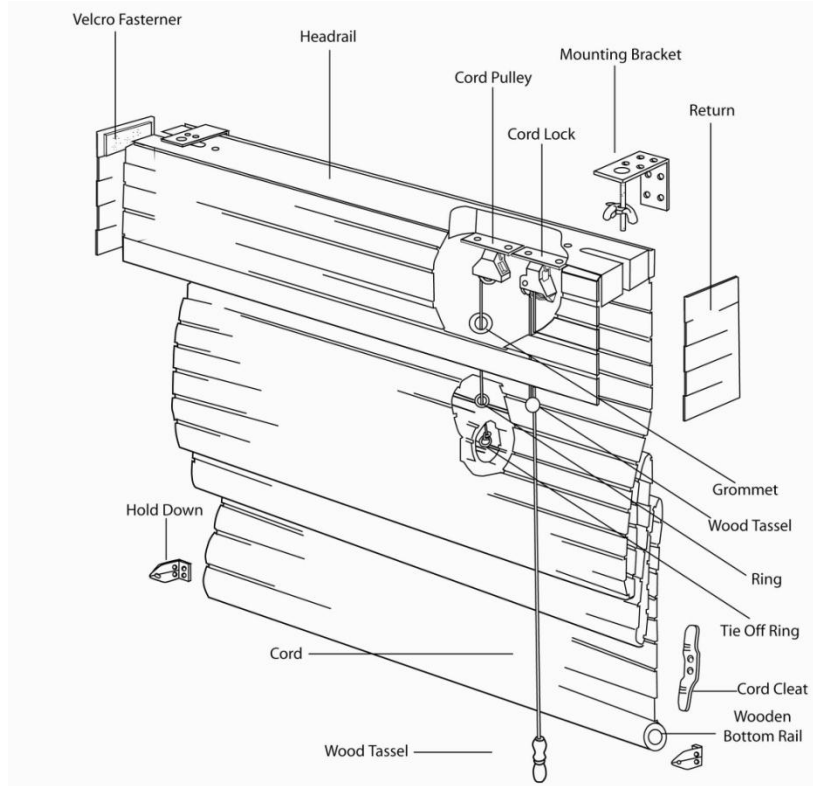

Folding Door Style Woven Wood Shade

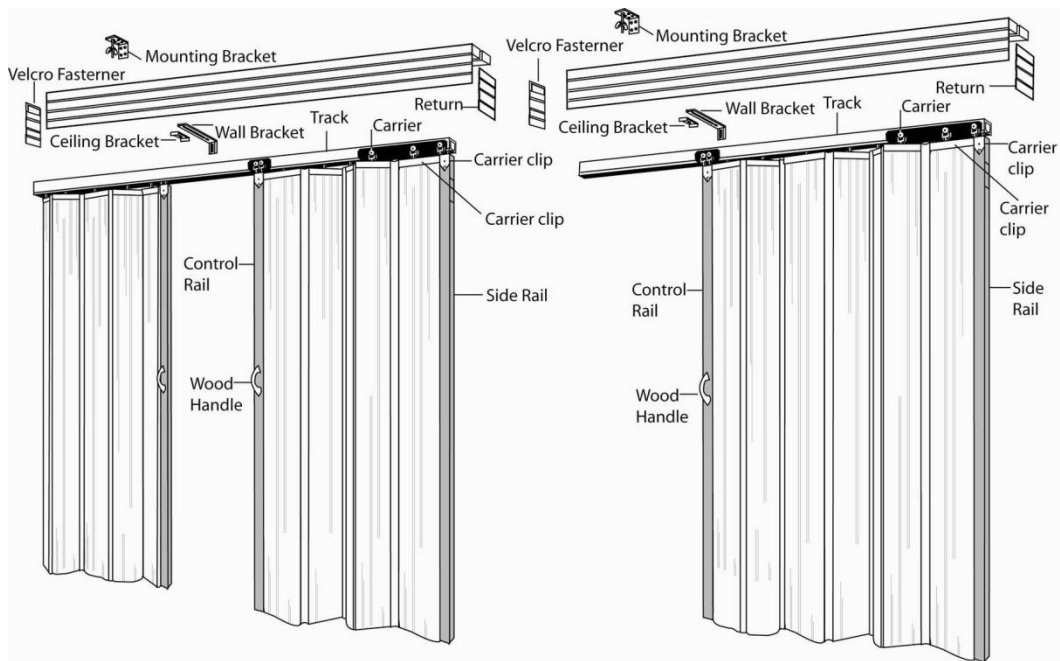

Split Draw

One Way Draw

Mariak

Many Window Solutions From One Source

Woven Wood Shade Options

Standard Style Woven Wood Shade

The Standard Style woven wood shade has the lift control cord in *front* of the shade. When completely down, the shade lays flat covering the window. When raised, the material rises from the bottom in flat folds. This shade option includes a 6" valance.

Minimum Width: 12"
Maximum Width: 96"
Minimum Height: 12"
Maximum Height: 108"

Optional Continuous Cord Loop is available.
See Retail Price Tables for surcharge.

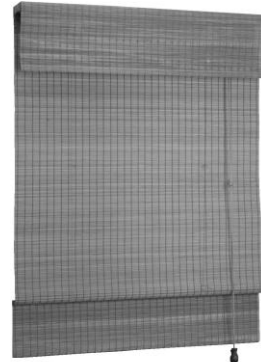

Waterfall Style Woven Wood Shade

The Waterfall Style woven wood shade offers the lift control cord *behind* the shade. The material is attached to the front of the headrail without a valance. When completely down, the shade lays flat covering the window. When raised, the material rises from the bottom in flat folds.

Minimum Width: 12"
Maximum Width: 96"
Minimum Height: 12"
Maximum Height: 108"

Optional Continuous Cord Loop is available.
See Retail Price Tables for surcharge.



Twin Style Woven Wood Shade

The Twin style shade features two separate, independently operated shades on one headrail. The front shade may be either a Standard Style shade or a Waterfall Style shade in natural woven wood material. A separate liner shade is attached to the back of the headrail. Both shades operate independently with lift cords at opposite sides of the shade.

Minimum Width: 12"
Maximum Width: 96"
Minimum Height: 12"
Maximum Height: 108"

Optional Continuous Cord Loop is available for both Front Shade only and for Front Shade and Back Liner. If this option is selected for both Front Shade and Back Liner, add the Cord Loop surcharge twice.
See Retail Price Tables for surcharge.

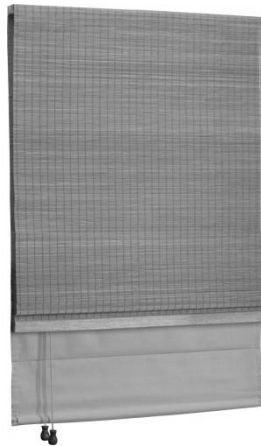

Continuous Loop Style Woven Wood Shade

The continuous loop style woven wood shade has a clutch lift mechanism that provides easier lifting of the shade and eliminates cord tangling. The control cord for this style of shade will always remain the same length. This option is available for Standard, Waterfall, and Twin Style Shades. It features an automatic locking device, which allows the shade to be stopped at any position. This option is strongly recommended for very large or heavy woven wood shades.

Continuous Loop Surcharge...Price as a standard shade and add the surcharge listed at the bottom of each Suggested Retail Price Table.

Minimum Width: 18"
Maximum Width: 96"
Minimum Height: 12"
Maximum Height: 108"

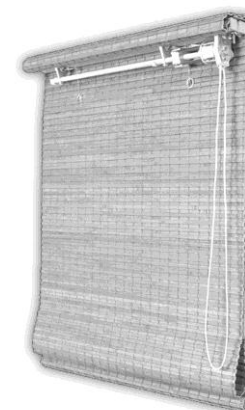

Mariak

Many Window Solutions From One Source

Top-Down/Bottom-Up Style Woven Wood Shade

The top-down/bottom-up style woven wood shade can be raised from the bottom or lowered from the top by two sets of lift cords located on opposite sides of the shade. The lift cords will be located in *front* of the shade. A 6" valance will be included to conceal the operating hardware. When raised, the material rises from the bottom in flat folds. The top-down/bottom-up option is available with only with Standard Style shades.

Top-Down/Bottom-Up Surcharge.....\$ 45.00 per shade

Minimum Width: 18"
Maximum Width: 60"
Minimum Height: 18"
Maximum Height: 72"

This option is not available for 3-On-1 headrail shades.
This option is not available with Continuous Cord Loop.

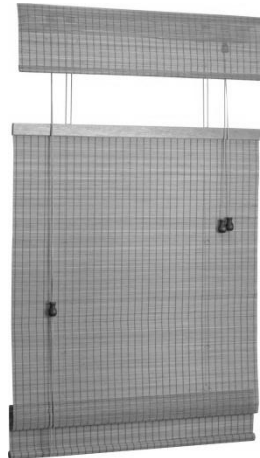

Arch Top Style Woven Wood Shade

This shade option includes an arch top style valance. A coordinating edge binding trim is included for this valance and a template for the arch is required.

• Arch Top Surcharge.....\$110.00 per shade

Minimum Width: 18"
Maximum Width: 72"
Minimum Height: 18"
Maximum Height: 72"

This option is not available with Continuous Cord Loop.

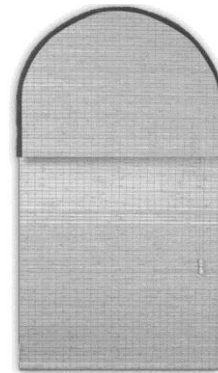

Angle Top Style Woven Wood Shade

This shade option includes an angle top with an angled valance.

• Angle Top Surcharge.....\$ 65.00 per shade

Minimum Width: 18"
Maximum Width: 72"
Minimum Height: 18"
Maximum Height: 72"

This option is not available with Continuous Cord Loop.

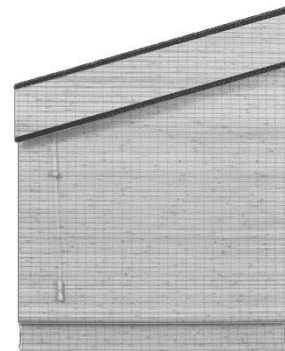

Multiple Woven Wood Shades On One Headrail

The multiple shades on 1 headrail option is a reasonable choice for large openings. The opening width is split into 2 or 3 individual shades with one common valance. Price as one overall shade and add the applicable surcharge listed below.

• 2—On—1 Headrail Surcharge...\$ 20.00 per opening
• 3—On—1 Headrail Surcharge...\$ 25.00 per opening

Minimum Width: 36"
Maximum Width: 96"
Minimum Height: 18"
Maximum Height: 108"

Optional Continuous Cord Loop is available.
See Retail Price Tables for surcharge.

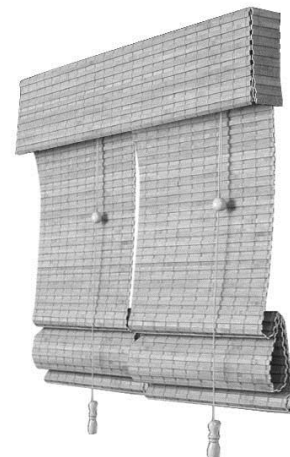

Mariak

Many Window Solutions From One Source

Ring Drapery Style Woven Wood Shade

Ring Drapery Panels are suitable for large windows or doors and hang from a drapery rod. Drapery rods are not included with the shade. If desired, please order a Decorative Wood or Bamboo Pole from the Soft Styles Section of the Price List. The drapery rod passes through antique brass rings (1-1/2" diameter) in the edge binding fabric at the top of the drapery panels.

Depending on the width, Ring Drapery Panels have between 30% to 50% fullness. Not all patterns can be used for Ring Drapery Panels. Ring Drapery Panels are bound on all four sides with edge binding fabric, which provides a soft, drapery look, protects the edges from damage, and adds a touch of color.

When ordering Ring Drapery Panels, it is required to select an edge binding color.

Minimum Width: 42"
Maximum Width: 120"
Minimum Height: 36"
Maximum Height: 96"

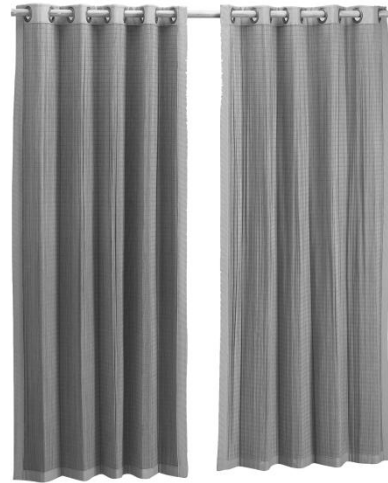

Folding Door Style Woven Wood Shade

The folding door style woven wood shade is optimal for sliding glass doors. They may also be used as room dividers. Folding door shades are only recommended for outside mount installations. Edge binding is not an available option for this style of shade. Please note that the fabric used for folding door shades are railroaded, or turned 90° sideways. A valance is not included, but is available for an additional surcharge. The direction of the fabric used to make the valance will be cut straight or opposite the way it appears in the folding door shade.

Minimum Width: 36"
Maximum Width: 144"
Minimum Height: 18"
Maximum Height: 96"

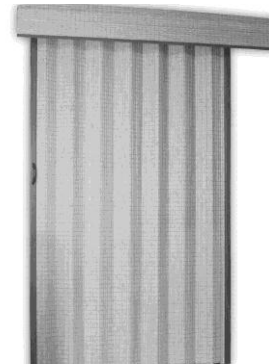

Please note: Valances are not included, but available for an additional charge.

Lining Options:

Privacy Lining:

Provides complete privacy & filters light by more than 50%.

- Available as Natural, Beige, and Chocolate
- Note: *Chocolate Liner is Natural Color to Street-side*

Black-Out Lining:

Provides complete privacy and blocks sunlight with the exception of side light gaps.

- Available in White, Beige, and Chocolate
- Note: *Chocolate Liner is Natural Color to Street-side*

Surcharges will apply.



Edge Binding Options:

Edge binding is an excellent method of both protecting the ends of the shade fabric and adding a color accent to the shade. Edge binding is 3" in width (1 1/2" on the face of the shade). It is applied to the sides of the shade and valance and (if applicable) across the bottom of the shade.

- Available in 12 different color choices: *Ecru, Beige, Mocha, Camel, Sage, Chocolate, Harbor Grey, Smoke, Leaf Green, Black, Brick, and Raspberry*
- Not available with Hold Downs or Wood Bottom Bars.

Surcharges will apply.

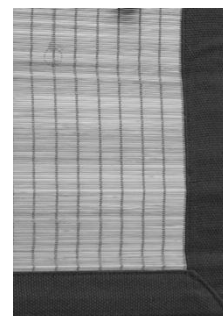

Mariak

Many Window Solutions From One Source

Woven Wood Shade Motorization

Motorized Woven Wood Shade

Woven Wood Shades can be powered by a variety of motors. At the press of a button, shades can be raised up, exposing a room to sunlight, or lowered down, Filtering Light from a room. Motorized Woven Woods will have a lift cord in back; the motor is in a tube and the cords roll-up onto the tube.



RF Hand-Held Transmitters & Wireless Wall Switches are available in 1 & 5 Channel models

Battery Powered Radio Frequency Motors:

Smaller shades may be operated by a battery powered motor system. This unique motor system has full lift control of shades that are up to 12.5 lbs. The motor is powered by AA lithium battery packs, which can be mounted to the ceiling or installed to the wall. The battery life expectancy is 1 to 2 years (based upon 2 operations per day and the weight of the shade). Battery Powered Woven Wood Shades are available with radio frequency controls. These motors have a built-in radio frequency receiver that communicates with a hand held remote control transmitter or a wireless wall switch via radio waves. Woven Wood Shades controlled by radio frequency may be operated as an individual unit, as sub-groups, and as an entire group. Please consult Mariak technical support with any questions you may have.

Minimum Width:	24"	Battery Powered Motor Surcharges:	
Maximum Width:	72"	Battery Powered Motor (Radio Frequency – 12 Volt)	\$400.00 (Net Pricing)
Minimum Height:	24"	Radio Frequency Transmitter 1-Ch	\$ 61.00 (Net Pricing)
Maximum Height:	72"	Radio Frequency Transmitter 5-Ch	\$ 80.00 (Net Pricing)
		Radio Frequency Wireless Wall Switch 1-Ch	\$146.00 (Net Pricing)
		Radio Frequency Wireless Wall Switch 5-Ch	\$153.00 (Net Pricing)

24-Volt DC (Low Voltage) Powered Plug-In or Hardwired Radio Frequency Motors:

This Woven Wood Shade is operated by a 24-volt DC 2-wire motor. The motor may be plugged-in to a standard electrical wall outlet with a 24-volt transformer or hardwired via low voltage wiring if desired. A variety of low voltage transformers are available for an additional charge. These motors have a built-in radio frequency receiver that communicates with a hand held remote control transmitter or a wireless wall switch via radio waves. The electronic controls for this type of motor are capable of operating a shade individually, as sub-groups, and as an entire group. Please consult Mariak technical support with any questions you may have.

Minimum Width:	24"	24-Volt DC (Low Voltage) Powered Motor Surcharges:	
Maximum Width:	96"	DC Powered Motor (Radio Frequency – 12 Volt)	\$415.00 (Net Pricing)
Minimum Height:	24"	Radio Frequency Transmitter 1-Ch	\$ 61.00 (Net Pricing)
Maximum Height:	96"	Radio Frequency Transmitter 5-Ch	\$ 80.00 (Net Pricing)
		Radio Frequency Wireless Wall Switch 1-Ch	\$146.00 (Net Pricing)
		Radio Frequency Wireless Wall Switch 5-Ch	\$153.00 (Net Pricing)

Please consult Mariak technical support for assistance with selecting and pricing the appropriate low voltage transformer.

110-Volt AC Powered Plug-In Radio Frequency Motors: (Most Popular Motor Option!) This Woven Wood Shade is operated by a 110-volt AC 3-wire motor. The motor may be plugged-in to a standard 3-prong electrical wall outlet or hardwired if desired. For your convenience, the shade is shipped from the factory with a plug installed at the end of the motor cable. If so desired, the plug may be cut off and hardwired to a dedicated power supply by a licensed electrician. These motors have a built-in radio frequency receiver that communicates with a hand held remote control transmitter or a wireless wall switch via radio waves. The electronic controls for this type of motor are capable of operating a shade individually, as sub-groups, and as an entire group. Please consult Mariak technical support with any questions you may have.

Minimum Width:	30"	110-Volt AC Powered Plug-In Radio Frequency Motor Surcharges:	
Maximum Width:	120"	AC Powered Plug-In Motor (Radio Frequency – 110 Volt)	\$420.00 (Net Pricing)
Minimum Height:	24"	Radio Frequency Transmitter 1-Ch	\$ 61.00 (Net Pricing)
Maximum Height:	120"	Radio Frequency Transmitter 5-Ch	\$ 80.00 (Net Pricing)
		Radio Frequency Wireless Wall Switch 1-Ch	\$146.00 (Net Pricing)
		Radio Frequency Wireless Wall Switch 5-Ch	\$153.00 (Net Pricing)

110-Volt AC Powered Standard Hardwired Motors:

This Woven Wood Shade is operated by a 110-volt AC 4-wire motor. It requires the motor to be hardwired or installed such that the power supply must be fixed and permanent. In other words, wires from a power source within the wall must be connected by a licensed electrician so that the motor receives a constant power supply at all times. A variety of electronic controls for hardwired motorized Woven Wood Shades are capable of operating a shade individually, as sub-groups, and/or as an entire group. Please consult Mariak technical support with any questions you may have.

Minimum Width:	30"	110-Volt AC Powered Standard Hardwired Motor Surcharges:	
Maximum Width:	120"	AC Powered Plug-In Motor (Hardwired – 110 Volt)	\$385.00 (Net Pricing)
Minimum Height:	24"	Basic Wall Switch	\$ 20.00 (Net Pricing)
Maximum Height:	120"	(A wide variety of hardwired motor group controllers are available upon request.)	

Additional Woven Wood Shade Information

Factory Deductions: Inside mount shades have a $\frac{3}{8}$ " deduction in width.

Fabric Information:

Yarns – A wide array of natural and man made fibers are used in the making of the yarns featured in woven wood fabrics. Pure, bright colors are achieved by using the finest dyes available. Even so, over a period of time slight fading may occur.

Stretching – All natural woven wood shades may stretch; this is an inherent trait for these fabrics.

Color Variation – Both the paints and stains on natural fabrics are subject to color variation. Reed and wood slats will retain the unique grain, nodes, color, and shape irregularities inherent from natural woods, water reeds, and grasses.

Fading – Over an extended period of time, exterior and interior discoloration may occur. The colors may become more yellow after exposed to strong sunlight. The use of a privacy lining will minimize fading.

Stretching, Color Variation, and Fading are natural characteristics of woven wood shades. The occurrence of these changes is industry standard and will not warrant a replacement shade.

Energy Savings – Woven wood fabrics are a good insulator against the summer's heat and winter's cold.

Headrail Dimensions:

Headrail Type	Dimensions
Standard Pull Cord (Cord Lock) Woven Wood Shades	1 ½" x ¾"
Continuous Cord Loop, Battery Motors, & DC (Low Voltage) Motors Twin Shade with Standard Pull Cord for both Front Shade & Back Liner	2 ½" x ¾"
AC (High Voltage) Motorized Woven Wood Shades Twin Shade with Cord Loop Front Shade & Pull Cord Back Liner	3" x ¾"
Twin Shade with Cord Loop for both Front Shade & Back Liner	5" x ¾"

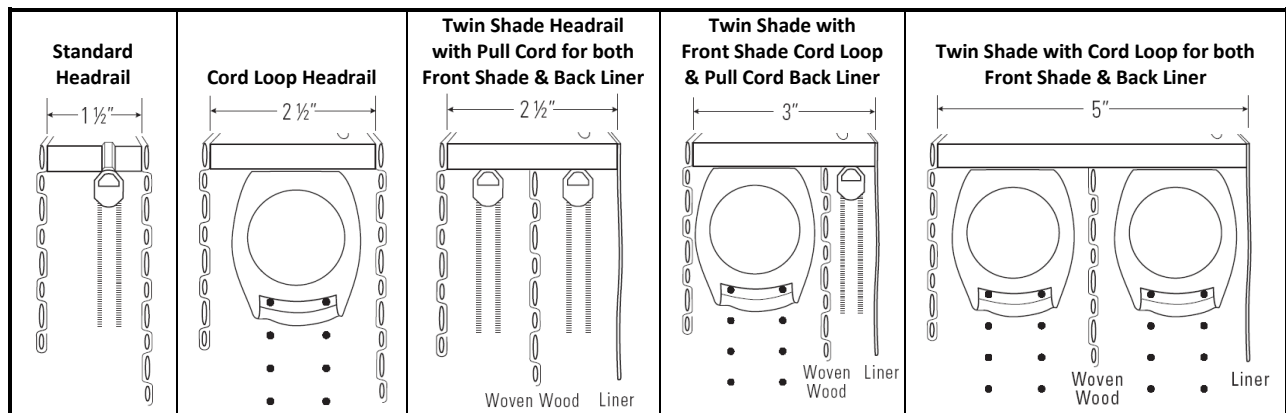

Stack Height Chart:

Height of Shade	Total Thickness
	Traditional Roman Fold
Up To ~84"	~9"
85 - 120"	~10"

Note: These are estimated measurements and may vary from shade type to shade type and fabric to fabric.

Cleaning Instructions:

Woven wood shades are designed to be durable and are easily cleaned. These fabrics are inherently anti-static and repel dust. Occasional feather dusting or light vacuuming may be necessary to keep the fabrics clean and bright.

Mariak

Many Window Solutions From One Source

Bracket Dimensions

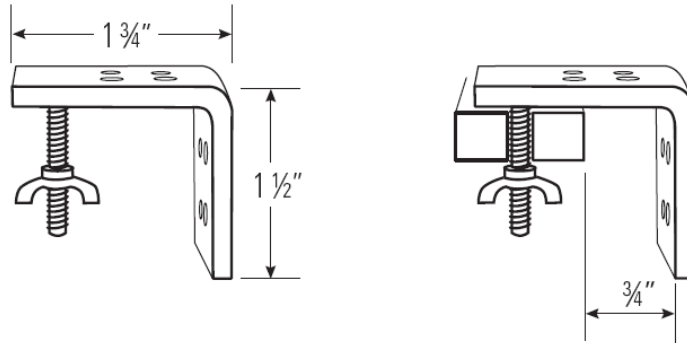

Inside Mount Depths

Minimum Required Depth: 3/4" with standard bracket

Flush Mount Required Depth: Headrail size plus 1" if using standard bracket.

Exact flush inside mount depths will vary slightly based upon the thickness of the fabric selected.

Safety Information:

To insure child safety, it is strongly recommended that each shade be installed with a cord safety cleat provided by the manufacturer.

No Charge Options:

Hold-Down Brackets are available upon request, but are not available with Edge Binding or Wood Bottom Bar options.

Spacer Blocks are available upon request.

Cut Outs:

Cut outs can be taken from either side of the shade. Please provide exact dimensions and the locations of the cut outs required. There may be limitations to what can be cut out, based on the size and specifications of the shade.

Cord Shrouds:

Cords on the back of the shade are wrapped in a "cord shroud" for increased safety against strangulation hazard. This allows the shade to fold normally, but does not allow a hazardous loop to be formed since the lift cord cannot be pulled out on the back of the shade any further than the spacing between the lift rings.



Surcharge of \$ 1.50 per shade will automatically be applied to all Woven Wood Shades.

In compliance with the latest manufacturing safety guidelines (ANSI/WCMA standard section 6.5.2) Mariak Window Fashions includes with each fully-assembled product warning tags, warning labels, safety devices and cord cleats. Installers of the finished product must adhere to the safety guidelines as established by the installation instructions and by using all devices provided by the manufacturer. It is the responsibility of the installer, as well as the end consumer, to see that all safety devices are properly installed according to the manufacturers installation instructions included with each device and remain so throughout the life of the product. Mariak Window Fashions is not liable for injuries or fatal occurrences related to improper installation or maintenance of required safety devices.



Mariak

Many Window Solutions From One Source

Woven Wood Pattern Index (8-10-11)

Pattern	Color Code	Price Table	Edge Binding	Folding Door	Ring Drapery Panel	Recommended Wood Bottom Bar Color
ABACA BEIGE	WL 8811B	D	Y	N/A	N/A	Sugar Maple
ABACA BROWN	WL 7230B	D	Y	N/A	N/A	Walnut
ABACA RED EARTH	WL 8811R	D	Y	N/A	N/A	Spice
ABACA SAGE	WL 8813S	D	Y	N/A	N/A	Driftwood
AKITA CARBON	WL 3100R	C	Y	Y	Y	Sugar Maple
AKITA GOLD	WL 3080G	C	Y	Y	Y	Sugar Maple
AKITA HAZELNUT	WL 3030H	C	Y	Y	Y	Espresso
AKITA OAK	WL 3010K	C	Y	Y	Y	Walnut
AKITA WALNUT	WL 3050W	C	Y	Y	Y	Walnut
AURORA CHERRY	WL 3200C	B	Y	Y	Y	Spice
AURORA WALNUT	WL 5186W	B	Y	Y	Y	Walnut
BAMBOO PALM CARBON	WL 4100R	C	Y	Y	Y	Driftwood
BAMBOO PALM DARK OAK	WL 4100D	C	Y	Y	Y	Spice
BAMBOO PALM ESPRESSO	WL 4100E	C	Y	Y	Y	Espresso
BAMBOO PALM WALNUT	WL 4100W	C	Y	Y	Y	Spice
BAMBOO REEDS WHEAT	WL 2040W	B	N/A	N/A	N/A	Natural
BAMBOO WEAVE CAMEL	WL 2060C	B	N/A	N/A	N/A	Sugar Maple
BORA BORA NATURAL	WL 8861N	B	Y	Y	Y	Natural
BORNEO DAPPLED	WL 7291D	B	Y	Y	Y	Sugar Maple
CABANA PECAN	WL 8036P	B	Y	Y	Y	Spice
CABANA SADDLE	WL 8036S	B	Y	Y	Y	Sugar Maple
CALYPSO SPRING	WL 7231S	C	Y	Y	Y	Sugar Maple
CARIBE SPICE	WL 5243S	D	Y	N/A	N/A	Walnut
DRIFTWOOD NATURAL	WL 5068N	A	Y	Y	Y	Natural
FOREST GRASS SAGE	WL 0235S	C	Y	Y	Y	Driftwood
HARMONY NATURAL	WL 4970N	D	Y (Recommended)	N/A	N/A	Natural
HARMONY SPICE	WL 4970S	D	Y (Recommended)	N/A	N/A	Walnut
KYOTO BROWN	WL 5646B	A	Y	Y	Y	Walnut
KYOTO MERLOT	WL 5647M	A	Y	Y	Y	Spice
LAGUNA UMBER	WL 8867U	A	N/A	N/A	N/A	Sugar Maple
LATICE TWILIGHT	WL 8074D	A	Y	Y	Y	Espresso
MANDALAY OAK	WL 5087K	A	Y	Y	Y	Sugar Maple
MANDALAY PISTACHIO	WL 5052P	A	Y	Y	Y	Natural
MEDAN CARMEL	WL 5056C	A	Y	N/A	N/A	Sugar Maple
MONTEREY OAK	WL 6914K	A	Y	Y	Y	Sugar Maple
NOCTURNE EBONY	WL 5186E	B	Y	Y	Y	Natural
PARCHMENT BLEACHED	WL 7253B	C	Y (Recommended)	N/A	N/A	Natural
PENANG OAK	WL 5057K	A	Y	Y	Y	Sugar Maple
PRAIRIE BRUSHWOOD	WL 0209B	D	Y (Recommended)	N	N	Walnut
PRAIRIE NATURAL	WL 7249N	D	Y (Recommended)	N/A	N/A	Driftwood
PRAIRIE RUSSET	WL 7254R	D	Y (Recommended)	N/A	N/A	Spice
RAFFIA BARK	WL 7252B	D	Y (Recommended)	N/A	N/A	Walnut
RAFFIA SAND	WL 7252S	D	Y (Recommended)	N/A	N/A	Natural
RIVER CANE SAGE	WL 5016S	D	Y	Y	Y	Sugar Maple
RUSTIC PECAN	WL 8021P	B	Y	Y	Y	Walnut
RUSTIC SADDLE	WL 1003S	B	Y	Y	Y	Sugar Maple
RUSTIC TAN	WL 8017T	B	Y	Y	Y	Sugar Maple
SAMOA CINNAMON	WL 4895S	C	Y	Y	Y	Sugar Maple
SAVANNA NIGHTSHADE	WL 7415N	D	Y (Recommended)	N/A	N/A	Espresso
SISAL NATURAL	WL 5151N	D	Y	Y	Y	Driftwood
ST. MARTIN	WL 8031C	D	Y	Y	Y	Walnut
SUMATRA ESPRESSO	WL 5002E	B	Y	N/A	N/A	Espresso
SUMATRA SADDLE	WL 5002S	B	Y	N/A	N/A	Walnut
SUN SHADE BROWN	WL 5049B	B	Y	Y	Y	Walnut
SUN SHADE NATURAL	WL 5049N	B	Y	Y	Y	Natural
SUN SHADE WHITE	WL 5049W	C	Y	N/A	N/A	Natural
SUNFLOWER GOLD	WL 5106G	A	Y	Y	Y	Sugar Maple
TAMARIND BROWN	WL 7248B	C	Y	Y	Y	Spice
TIKI CARBON	WL 0120C	A	Y	Y	Y	Walnut
WESTPORT NUTMEG	WL 8865N	B	Y	Y	Y	Spice

BLANK PAGE



**West Lake Woven Wood Shades
Standard & Waterfall Style Shades**

Suggested Retail Price Table #A

		Width										
		24	30	36	42	48	60	72	84	96	108	120
Length	36	72	83	95	107	125	152	184	208	232	261	290
	48	78	89	101	119	137	166	196	232	249	281	312
	54	83	95	111	131	155	187	221	258	294	331	368
	60	89	103	123	143	169	202	245	286	327	368	409
	66	95	113	135	158	180	223	270	315	360	405	450
	72	101	123	147	172	196	245	294	343	392	441	490
	78	107	133	160	186	213	266	319	372	425	479	532
	84	116	143	172	200	229	282	343	400	458	516	573
	90	122	152	184	215	240	303	368	429	490	552	613
	96	131	160	196	229	249	315	392	463	534	601	668
	108	167	204	220	258	280	354	441	520	600	675	750
	Cord Loop	45	53	60	65	68	70	75	80	85	93	101
Wood Bottom Bar	34	41	45	52	56	67	78	89	100	N/A	N/A	

Note: Shades measuring more than 72" in width are recommended with a continuous cord loop control.

Price Group A Patterns: Driftwood Lattice Monterey Tiki
 Kyoto Mandalay Penang
 Laguna Medan Sunflower

Woven Wood Surcharge Options	
Cutouts	\$15.00 per cutout
Top-Down/Bottom-Up	\$45.00
Two-On-One Headrail	\$20.00 (price as one overall shade)
Three-On-One Headrail	\$25.00 (price as one overall shade)
Liners = Refer to Page 13	
Twin Shade = Refer to Pages 14 - 17	
Shades up to 92" in width shipped via FedEx: \$ 4.00 per unit Net Freight Charge	
Shades 92 1/8" to 125" in width shipped via FedEx: \$ 75.00 per unit Net Freight Charge	
Shades 125 1/8" or greater in width shipped via Common Carrier: \$ 150.00 per shipment	

Surcharge of \$ 1.50 per shade will automatically be applied to all Woven Wood Shades for Cord Shrouds.

West Lake Woven Wood Shades Standard & Waterfall Style Shades

Suggested Retail Price Table #B

		Width										
		24	30	36	42	48	60	72	84	96	108	120
Length	36	89	113	128	140	163	178	213	256	288	324	360
	48	98	122	143	169	190	212	252	285	321	362	402
	54	116	134	155	181	199	222	265	298	348	392	435
	60	128	143	166	190	217	233	279	329	378	426	473
	66	137	155	178	202	229	260	316	369	423	476	529
	72	146	163	190	214	240	283	344	400	453	510	567
	78	155	172	199	226	259	307	368	430	491	553	614
	84	163	181	211	244	279	331	400	463	529	596	662
	90	172	190	224	261	298	354	425	496	566	637	708
	96	181	202	239	279	318	378	453	529	604	680	755
	108	204	227	269	313	358	425	510	595	680	765	850
	Cord Loop	45	53	60	65	68	70	75	80	85	93	101
Wood Bottom Bar	34	41	45	52	56	67	78	89	100	N/A	N/A	

Note: Shades measuring more than 72" in width are recommended with a continuous cord loop control.

Price Group B Patterns: Aurora Bora Bora Nocturne Sunshade (Stains)
 Bamboo Reeds Borneo Rustic Westport
 Bamboo Weave Cabana Sumatra

Woven Wood Surcharge Options	
Cutouts	\$15.00 per cutout
Top-Down/Bottom-Up	\$45.00
Two-On-One Headrail	\$20.00 (price as one overall shade)
Three-On-One Headrail	\$25.00 (price as one overall shade)
Liners = Refer to Page 13	
Twin Shade = Refer to Pages 14 - 17	
Shades up to 92" in width shipped via FedEx: \$ 4.00 per unit Net Freight Charge	
Shades 92 1/8" to 125" in width shipped via FedEx: \$ 75.00 per unit Net Freight Charge	
Shades 125 1/8" or greater in width shipped via Common Carrier: \$ 150.00 per shipment	

Surcharge of \$ 1.50 per shade will automatically be applied to all Woven Wood Shades for Cord Shrouds.



**West Lake Woven Wood Shades
Standard & Waterfall Style Shades**

Suggested Retail Price Table #C

		Width										
		24	30	36	42	48	60	72	84	96	108	120
Length	36	101	125	149	166	187	232	271	325	370	417	463
	48	113	137	158	178	199	243	300	344	400	450	500
	54	125	149	169	190	217	255	314	366	418	471	523
	60	134	160	178	204	233	279	341	398	465	524	582
	66	143	169	192	224	256	309	368	447	511	575	639
	72	155	181	209	244	279	332	409	488	557	627	697
	78	163	193	227	264	302	368	451	528	604	680	755
	84	172	204	244	285	320	392	473	552	631	710	789
	90	181	218	258	303	338	427	507	591	676	761	845
	96	190	233	273	320	356	445	541	631	721	812	902
	108	214	262	307	360	400	500	608	710	811	913	1014
	Cord Loop	45	53	60	65	68	70	75	80	85	93	101
Wood Bottom Bar	34	41	45	52	56	67	78	89	100	N/A	N/A	

Note: Shades measuring more than 72" in width are recommended with a continuous cord loop control.

Price Group C Patterns: Akita Forest Grass Sunshade (White)
 Bamboo Palm Parchment*** Tamarind
 Calypso Samoa

***Note: Parchment cannot be fabricated wider than 96".

Cutouts	\$15.00 per cutout
Top-Down/Bottom-Up	\$45.00
Two-On-One Headrail	\$20.00 (price as one overall shade)
Three-On-One Headrail	\$25.00 (price as one overall shade)
Liners = Refer to Page 13	
Twin Shade = Refer to Pages 14 - 17	
Shades up to 92" in width shipped via FedEx:	\$ 4.00 per unit Net Freight Charge
Shades 92 1/8" to 125" in width shipped via FedEx:	\$ 75.00 per unit Net Freight Charge
Shades 125 1/8" or greater in width shipped via Common Carrier:	\$ 150.00 per shipment

Surcharge of \$ 1.50 per shade will automatically be applied to all Woven Wood Shades for Cord Shrouds.



**West Lake Woven Wood Shades
Standard & Waterfall Style Shades**

Suggested Retail Price Table #D

		Width										
		24	30	36	42	48	60	72	84	96	108	120
Length	36	119	137	158	184	205	249	294	341	386	435	483
	48	131	149	171	205	228	276	329	399	456	513	570
	54	143	160	184	223	257	309	380	449	513	578	642
	60	155	169	196	243	282	338	428	499	570	642	713
	66	166	181	208	258	300	374	470	549	627	706	784
	72	184	196	217	276	320	409	513	599	684	770	855
	78	196	208	232	312	350	428	528	616	704	792	880
	84	211	220	249	344	380	462	569	663	758	853	948
	90	223	235	273	368	400	490	609	711	812	914	1015
	96	235	249	291	386	427	532	650	758	866	975	1083
	108	264	280	327	434	480	599	731	853	975	1097	1219
	Cord Loop	45	53	60	65	68	70	75	80	85	93	101
Wood Bottom Bar	34	41	45	52	56	67	78	89	100	N/A	N/A	

Note: Shades measuring more than 72" in width are recommended with a continuous cord loop control.

Price Group D Patterns: Abaca Prairie St. Martin
 Caribe Raffia*** Savanna
 Harmony*** River Cane*** Sisal***

***Note: Harmony, Raffia, River Cage and Sisal cannot be fabricated wider than 96".

Woven Wood Surcharge Options	
Cutouts	\$15.00 per cutout
Top-Down/Bottom-Up	\$45.00
Two-On-One Headrail	\$20.00 (price as one overall shade)
Three-On-One Headrail	\$25.00 (price as one overall shade)
Liners = Refer to Page 13	
Twin Shade = Refer to Pages 14 - 17	
Shades up to 92" in width shipped via FedEx: \$ 4.00 per unit Net Freight Charge	
Shades 92 1/8" to 125" in width shipped via FedEx: \$ 75.00 per unit Net Freight Charge	
Shades 125 1/8" or greater in width shipped via Common Carrier: \$ 150.00 per shipment	

Surcharge of \$ 1.50 per shade will automatically be applied to all Woven Wood Shades for Cord Shrouds.



West Lake Woven Wood Shades
Additional Options for Standard & Waterfall Style Shades

Suggested Retail Price Table: Edge Bindings

		Width										
		24	30	36	42	48	60	72	84	96	108	120
Length	36	15	18	22	25	29	36	43	50	57	65	72
	48	19	24	29	34	38	48	57	67	76	86	95
	54	22	27	32	38	43	54	64	75	86	97	108
	60	24	30	36	42	48	60	72	83	95	107	119
	66	27	33	40	46	53	66	79	92	105	119	132
	72	29	36	43	50	57	72	86	100	114	129	143
	78	31	39	47	54	62	78	93	108	124	140	155
	84	34	42	50	59	67	83	100	117	133	150	167
	90	36	45	54	63	72	89	107	125	143	161	179
	96	38	48	57	67	76	95	114	133	152	171	190
108	43	54	64	75	86	107	128	150	171	193	214	

Suggested Retail Price Table: Privacy Liner - Natural, Beige, or Chocolate

		Width										
		24	30	36	42	48	60	72	84	96	108	120
Length	36	19	24	28	33	38	47	56	66	75	85	94
	48	25	32	38	44	50	63	75	88	100	113	125
	54	28	35	42	49	56	70	84	98	112	126	140
	60	32	39	47	55	63	78	94	109	125	141	157
	66	35	43	52	60	69	86	103	120	137	155	172
	72	38	47	56	66	75	94	112	131	150	169	188
	78	41	51	61	71	81	102	122	142	162	183	203
	84	44	55	66	77	88	109	131	153	175	197	219
	90	47	59	70	82	94	117	140	164	187	211	234
	96	50	63	75	88	100	125	150	175	200	225	250
108	56	70	84	98	112	140	168	196	224	252	280	

Suggested Retail Price Table: Black-Out Liner - White, Beige, or Chocolate

		Width										
		24	30	36	42	48	60	72	84	96	108	120
Length	36	24	30	36	42	48	60	72	84	96	108	120
	48	32	40	48	56	64	80	96	112	128	144	160
	54	36	45	54	63	72	90	108	126	144	162	180
	60	40	50	60	70	80	100	120	140	160	180	200
	66	44	55	66	77	88	110	132	154	176	198	220
	72	48	60	72	84	96	120	144	168	192	216	240
	78	52	65	78	91	104	130	156	182	208	234	260
	84	56	70	84	98	112	140	168	196	224	252	280
	90	60	75	90	105	120	150	180	210	240	270	300
	96	64	80	96	112	128	160	192	224	256	288	320
108	72	90	108	126	144	180	216	252	288	324	360	

Suggested Retail Price Table: Liner for Valance

		Width										
		24	30	36	42	48	60	72	84	96	108	120
		5	6	6	7	7	9	10	11	12	13	14

Mariak

Many Window Solutions From One Source

West Lake Woven Wood Shades Twin Style Shades With Privacy Liner

Suggested Retail Price Table: Twin Shade with Privacy Liner - Group A Patterns
Width

Length	Width								
	24	30	36	42	48	60	72	84	96
36	107	125	142	160	187	227	275	311	346
48	116	133	151	178	204	249	294	346	373
54	125	142	165	196	231	280	330	385	440
60	133	153	184	214	253	302	367	428	489
66	142	168	202	236	269	333	404	471	538
72	151	184	220	257	294	367	440	513	587
78	160	199	239	278	318	397	477	556	636
84	173	214	257	300	342	422	513	599	684
90	182	227	275	321	360	453	550	642	733
96	196	240	293	342	373	470	587	692	798
108	220	270	330	385	419	529	660	779	898
Cord Loop	45	53	60	65	68	70	75	80	85
Wood Bottom Bar	34	41	45	52	56	67	78	89	100

Price Group A Patterns: Driftwood Lattice Monterey Tiki
 Kyoto Mandalay Penang
 Laguna Medan Sunflower

Suggested Retail Price Table: Twin Shade with Privacy Liner - Group B Patterns
Width

Length	Width								
	24	30	36	42	48	60	72	84	96
36	120	152	179	211	239	299	358	422	474
48	132	164	191	227	255	315	374	446	502
54	156	179	207	243	267	331	394	466	534
60	172	191	223	255	291	347	414	490	561
66	183	207	239	271	307	367	446	522	597
72	195	219	255	287	323	400	486	565	640
78	207	231	267	304	347	434	520	607	694
84	219	243	283	327	374	467	565	654	747
90	231	255	300	350	400	500	600	700	800
96	243	271	320	374	427	534	640	747	854
108	273	305	360	420	480	600	720	840	960
Cord Loop	45	53	60	65	68	70	75	80	85
Wood Bottom Bar	34	41	45	52	56	67	78	89	100

Price Group B Patterns: Alina Bora Bora Rustic
 Aurora Borneo Sumatra
 Bamboo Reeds Cabana Sunshade (Stains)
 Bamboo Weave Nocturne Westport

Woven Wood Surcharge Options	
Two-On-One Headrail	\$20.00 (price as one overall shade)
Three-On-One Headrail	\$25.00 (price as one overall shade)
Shades up to 92" in width shipped via FedEx: \$ 4.00 per unit Net Freight Charge	
Shades 92 1/8" to 125" in width shipped via FedEx: \$ 75.00 per unit Net Freight Charge	
Shades 125 1/8" or greater in width shipped via Common Carrier: \$ 150.00 per shipment	
Surcharge of \$ 1.50 per shade will automatically be applied to all Woven Wood Shades for Cord Shrouds.	

8-10-11 kb

Mariak

Many Window Solutions From One Source

West Lake Woven Wood Shades Twin Style Shades With Privacy Liner

Suggested Retail Price Table: Twin Shade with Privacy Liner - Group C Patterns
Width

Length	Width								
	24	30	36	42	48	60	72	84	96
36	122	150	179	200	225	279	340	397	450
48	136	165	190	215	240	293	361	415	482
54	150	179	204	229	261	308	378	441	504
60	161	193	215	245	280	336	411	479	560
66	172	204	231	270	308	372	443	539	616
72	186	218	252	294	336	400	493	588	672
78	197	233	273	319	364	443	543	637	728
84	208	245	294	343	386	472	588	686	783
90	218	263	311	365	407	515	630	735	839
96	229	280	329	386	429	536	672	783	895
108	258	315	370	434	482	603	755	881	1007
Cord Loop	45	53	60	65	68	70	75	80	85
Wood Bottom Bar	34	41	45	52	56	67	78	89	100

Price Group C Patterns: Akita Forest Grass Sunshade (White)
 Bamboo Palm Parchment*** Tamarind
 Calypso Samoa

Suggested Retail Price Table: Twin Shade with Privacy Liner - Group D Patterns
Width

Length	Width								
	24	30	36	42	48	60	72	84	96
36	133	153	177	207	230	280	330	383	433
48	147	167	192	230	256	310	370	448	512
54	160	180	207	250	288	346	426	504	576
60	173	190	220	273	316	380	480	560	640
66	187	203	233	290	336	419	528	616	704
72	207	220	243	310	360	459	576	672	768
78	220	233	260	350	393	506	624	728	831
84	237	247	280	386	426	546	672	784	895
90	250	263	306	413	449	579	720	839	959
96	263	280	326	433	479	629	768	895	1023
108	296	315	367	487	539	707	863	1007	1151
Cord Loop	45	53	60	65	68	70	75	80	85
Wood Bottom Bar	34	41	45	52	56	67	78	89	100

Price Group D Patterns: Abaca Prairie St. Martin
 Caribe Raffia*** Savanna
 Harmony*** River Cane*** Sisal***

Woven Wood Surcharge Options	
Two-On-One Headrail	\$20.00 (price as one overall shade)
Three-On-One Headrail	\$25.00 (price as one overall shade)
Shades up to 92" in width shipped via FedEx: \$ 4.00 per unit Net Freight Charge	
Shades 92 1/8" to 125" in width shipped via FedEx: \$ 75.00 per unit Net Freight Charge	
Shades 125 1/8" or greater in width shipped via Common Carrier: \$ 150.00 per shipment	
Surcharge of \$ 1.50 per shade will automatically be applied to all Woven Wood Shades for Cord Shrouds.	

Mariak

Many Window Solutions From One Source

West Lake Woven Wood Shades Twin Style Shades With Black-Out Liner

Suggested Retail Price Table: Twin Shade with Black-Out Liner - Group A Patterns
Width

Length	24	30	36	42	48	60	72	84	96
36	115	135	154	173	202	245	297	336	374
48	125	144	163	192	221	269	317	374	403
54	135	154	179	211	249	302	357	416	475
60	144	165	198	231	273	326	396	462	528
66	154	182	218	254	291	360	436	508	581
72	163	198	238	278	317	396	475	555	634
78	173	215	258	301	343	429	515	601	686
84	187	231	278	324	370	455	555	647	739
90	197	245	297	347	388	489	594	693	792
96	211	259	317	370	403	508	634	747	862
108	237	291	356	416	453	571	713	841	970
Cord Loop	45	53	60	65	68	70	75	80	85
Wood Bottom Bar	34	41	45	52	56	67	78	89	100

Price Group A Patterns: Driftwood Lattice Monterey Tiki
 Kyoto Mandalay Penang
 Laguna Medan Sunflower

Suggested Retail Price Table: Twin Shade with Black-Out Liner - Group B Patterns
Width

Length	24	30	36	42	48	60	72	84	96
36	129	164	194	228	258	323	387	456	512
48	142	177	207	245	275	340	404	482	542
54	168	194	224	263	288	357	426	503	576
60	185	207	241	275	314	374	447	529	606
66	198	224	258	293	331	396	482	563	645
72	211	237	275	310	348	432	525	611	691
78	224	250	288	328	375	468	562	655	749
84	237	263	306	353	404	504	611	706	807
90	250	275	324	378	432	540	648	756	864
96	263	293	346	404	461	576	691	807	922
108	295	329	389	454	519	648	778	907	1037
Cord Loop	45	53	60	65	68	70	75	80	85
Wood Bottom Bar	34	41	45	52	56	67	78	89	100

Price Group B Patterns: Aurora Bora Bora Nocturne Sunshade (Stains)
 Bamboo Reeds Borneo Rustic Westport
 Bamboo Weave Cabana Sumatra

Woven Wood Surcharge Options	
Two-On-One Headrail	\$20.00 (price as one overall shade)
Three-On-One Headrail	\$25.00 (price as one overall shade)
Shades up to 92" in width shipped via FedEx: \$ 4.00 per unit Net Freight Charge	
Shades 92 1/8" to 125" in width shipped via FedEx: \$ 75.00 per unit Net Freight Charge	
Shades 125 1/8" or greater in width shipped via Common Carrier: \$ 150.00 per shipment	
Surcharge of \$ 1.50 per shade will automatically be applied to all Woven Wood Shades for Cord Shrouds.	

8-10-11kb

Mariak

Many Window Solutions From One Source

West Lake Woven Wood Shades Twin Style Shades With Black-Out Liner

Suggested Retail Price Table: Twin Shade with Black-Out Liner - Group C Patterns
Width

	24	30	36	42	48	60	72	84	96
36	132	162	193	216	243	301	367	428	486
48	147	178	205	232	259	317	390	448	521
54	162	193	220	247	282	332	408	476	544
60	174	209	232	265	302	363	444	517	604
66	186	220	250	291	333	401	479	582	665
72	201	236	272	318	363	432	533	635	725
78	213	251	295	344	393	479	587	688	786
84	224	265	318	370	417	509	635	740	846
90	236	284	336	394	440	556	680	793	906
96	247	302	355	417	463	579	725	846	967
108	278	340	400	469	521	651	816	952	1088
Cord Loop	45	53	60	65	68	70	75	80	85
Wood Bottom Bar	34	41	45	52	56	67	78	89	100

Price Group C Patterns: Akita Forest Grass Sedona
Bamboo Palm Parchment*** Sunshade (White)
Calypso Samoa Tamarind

Suggested Retail Price Table: Twin Shade with Black-Out Liner - Group D Patterns
Width

	24	30	36	42	48	60	72	84	96
36	144	166	191	223	248	302	356	413	467
48	159	180	208	248	277	334	399	484	553
54	173	194	223	270	311	374	460	544	622
60	187	205	238	295	342	410	518	605	691
66	202	220	252	313	363	453	570	665	760
72	223	238	263	334	388	496	622	725	829
78	238	252	281	378	424	546	674	786	898
84	255	266	302	417	460	589	725	846	967
90	270	284	331	446	485	625	777	907	1036
96	284	302	352	467	518	679	829	967	1105
108	320	340	396	526	582	764	932	1088	1243
Cord Loop	45	53	60	65	68	70	75	80	85
Wood Bottom Bar	34	41	45	52	56	67	78	89	100

Price Group D Patterns: Abaca Madras River Cane*** Sisal***
Caribe Prairie St. Martin
Harmony*** Raffia*** Savanna

Woven Wood Surcharge Options

Two-On-One Headrail	\$20.00 (price as one overall shade)
Three-On-One Headrail	\$25.00 (price as one overall shade)
Shades up to 92" in width shipped via FedEx: \$ 4.00 per unit Net Freight Charge	
Shades 92 1/8" to 125" in width shipped via FedEx: \$ 75.00 per unit Net Freight Charge	
Shades 125 1/8" or greater in width shipped via Common Carrier: \$ 150.00 per shipment	
Surcharge of \$ 1.50 per shade will automatically be applied to all Woven Wood Shades for Cord Shrouds.	



West Lake Woven Wood Shades Folding Door Shades

Suggested Retail Price Table #C

		Width							
		36	42	48	60	72	84	96	120
Length	36	141	161	181	221	259	299	339	424
	48	181	207	234	286	335	387	440	549
	60	222	254	287	351	412	476	540	675
	72	263	301	339	416	488	565	641	801
	84	303	348	392	481	565	653	741	927
	96	344	395	445	546	641	742	842	1052
	108	425	483	540	655	763	877	991	1230

Note: One-way folding door prices listed above.

Note: For split draw (center opening) folding door prices, cost as two separate shades and add Together.
 Note: Adaca, Parchment, & Sunshade (white) are not available as a folding door shade.

Price Group C Patterns: Akita Sedona (Max 97 3/4" Drop)
 Bamboo Palm Tamarind
 Calypso (Max 97 3/4" Drop)

Suggested Retail Price Table #D

		Width							
		36	42	48	60	72	84	96	120
Length	36	149	171	193	236	276	319	362	452
	48	193	221	249	306	358	414	470	587
	60	237	271	306	376	440	509	578	722
	72	280	322	363	446	523	604	686	858
	84	324	372	420	516	605	700	794	993
	96	368	422	476	585	687	795	903	1128
	108	452	514	576	700	815	938	1061	1317

Note: One-way folding door prices listed above.

Note: For split draw (center opening) folding door prices, cost as two separate shades and add Together.
 Note: Harmony, Monsoon, Prairie, Raffia, & Savanna are not available as folding door shades.

Price Group D Patterns: River Cane (Max 97 3/4" Drop) St. Martin
 Sakura (Max 97 3/4" Drop) Samoa
 Sisal (Max 97 3/4" Drop)

Folding Door Woven Wood Surcharge Options	
Split Draw (Center Opening)	Price as Two Separate Shades and Add Together
5% Fullness	5% is Standard (No Extra Charge)
20% Fullness	20%
Liners = Refer to Page 20	
Shades up to 92" in width and/or length shipped via FedEx: \$ 4.00 per unit Net Freight Charge	
Shades 92 1/8" to 125" in width and/or length shipped via FedEx: \$ 75.00 per unit Net Freight Charge	
Shades 125 1/8" or greater in width and/or length shipped via Common Carrier: \$ 150.00 per shipment	



Many Window Solutions From One Source

West Lake Woven Wood Shades Liner Options for Folding Door Shades

Suggested Retail Price Table: Privacy Liner

		Width							
		36	42	48	60	72	84	96	120
Length	36	45	52	60	75	89	104	119	149
	48	60	70	80	99	119	139	159	198
	60	75	87	99	124	149	173	198	247
	72	89	104	119	149	178	208	238	297
	84	104	121	139	173	208	242	277	346
	96	119	139	159	198	238	277	317	396
	108	136	159	181	226	271	317	362	452

Note: One-way folding door prices listed above.

Note: For split draw (center opening) folding door prices, cost as two separate shades and add Together.
Privacy Liner Colors: Natural, Beige, and Chocolate

Suggested Retail Price Table: Black-Out Liner

		Width							
		36	42	48	60	72	84	96	120
Length	36	56	65	75	93	112	130	149	186
	48	75	87	99	124	149	173	198	247
	60	93	109	124	155	186	217	247	309
	72	112	130	149	186	223	260	297	371
	84	130	152	173	217	260	303	346	433
	96	149	173	198	247	297	346	396	494
	108	170	198	226	283	339	396	452	565

Note: One-way folding door prices listed above.

Note: For split draw (center opening) folding door prices, cost as two separate shades and add Together.
Black-Out Liner Color: Soft White, Beige, and Chocolate

Folding Door Valance Pricing

Price Group A Patterns

		Width							
		36	42	48	60	72	84	96	120
		9	10	12	14	16	18	20	25

Price Group B Patterns

		Width							
		36	42	48	60	72	84	96	120
		15	17	19	22	26	30	34	42

Price Group C Patterns

		Width							
		36	42	48	60	72	84	96	120
		20	23	25	30	35	40	45	56

Price Group D Patterns

		Width							
		36	42	48	60	72	84	96	120
		32	36	40	48	56	64	72	90

West Lake Woven Wood Shades Ring Drapery Shades

Suggested Retail Price Table #A

		Width							
		42	48	60	72	84	96	102	120
Length	36	114	141	153	193	230	270	293	321
	48	149	185	201	252	302	353	385	420
	60	184	228	248	311	373	437	476	520
	72	220	272	295	371	445	520	568	620
	84	255	315	343	430	516	604	660	719
	96	290	358	390	490	588	688	751	819
	108	362	438	474	586	696	809	880	956

Note: All ring draperies are supplied as two panels unless otherwise specified.

Note: One-way opening ring draperies are available upon request, bu only up to 48" in width.

Note: Medan is not available as a ring drapery shade.

Note: Decorative hardware (drapery pole) not included. Select from Soft Styles Decorative Hardware options.

Price Group A Patterns:	Driftwood	Mandalay	Sunflower
	Kyoto	Monterey	Tiki
	Lattice	Penang	

Suggested Retail Price Table #B

		Width							
		42	48	60	72	84	96	102	120
Length	36	125	157	169	213	255	299	322	354
	48	164	206	221	279	335	392	423	465
	60	203	254	274	345	414	485	525	576
	72	242	303	326	411	494	578	626	687
	84	281	351	379	477	574	672	727	797
	96	320	400	432	543	653	765	828	908
	108	395	485	520	646	770	895	967	1057

Note: All ring draperies are supplied as two panels unless otherwise specified.

Note: One-way opening ring draperies are available upon request, bu only up to 48" in width.

Note: Bamboo Reeds, Bamboo Weave, & Sumatra are not available as ring drapery shades.

Note: Decorative hardware (drapery pole) not included. Select from Soft Styles Decorative Hardware options.

Price Group B Patterns:	Aurora	Cabana	Sunshade (Stains)
	Bora Bora	Nocturne	Westport
	Borneo	Rustic	

Ring Drapery Woven Wood Surcharge Options

Liners = Refer to Page 25

Shades up to 92" in length shipped via FedEx: \$ 4.00 per unit Net Freight Charge

Shades 92 1/8" to 125" in length shipped via FedEx: \$ 75.00 per unit Net Freight Charge

Shades 125 1/8" or greater in length shipped via Common Carrier: \$ 150.00 per shipment

West Lake Woven Wood Shades Liner Options for Ring Drapery Shades

Suggested Retail Price Table: Privacy Liner

		Width							
		42	48	60	72	84	96	102	120
Length	36	39	55	55	70	86	101	101	117
	48	52	73	73	94	114	135	135	156
	60	65	91	91	117	143	169	169	195
	72	78	109	109	140	171	202	202	234
	84	91	127	127	164	200	236	236	272
	96	104	146	146	187	228	270	270	311
	108	117	164	164	210	257	303	303	350

Note: All ring draperies are supplied as two panels unless otherwise specified.

Note: One-way opening ring draperies are available upon request, but only up to 48" in width.

Privacy Liner Colors: Natural, Beige, and Chocolate

Suggested Retail Price Table: Black-Out Liner

		Width							
		42	48	60	72	84	96	102	120
Length	36	46	64	64	83	101	119	119	137
	48	61	86	86	110	134	159	159	183
	60	77	107	107	137	168	198	198	229
	72	92	128	128	165	201	238	238	274
	84	107	150	150	192	235	277	277	320
	96	122	171	171	220	268	317	317	366
	108	137	192	192	247	302	356	356	411

Note: All ring draperies are supplied as two panels unless otherwise specified.

Note: One-way opening ring draperies are available upon request, but only up to 48" in width.

Black-Out Liner Color: Soft White, Beige, and Chocolate

Note: Bamboo Reeds, Bamboo Weave, & Sumatra are not available as ring drapery shades.

Note: Decorative hardware (drapery pole) not included. Select from Soft Styles Decorative Hardware options.

Price Group B Patterns:	Alina	Borneo	Rustic
	Aurora	Cabana	Sunshade (Stains)
	Bora Bora	Nocturne	Westport

Ring Drapery Woven Wood Surcharge Options
Liners = Refer to Page 25
Shades up to 92" in length shipped via FedEx: \$ 4.00 per unit Net Freight Charge
Shades 92 1/8" to 125" in length shipped via FedEx: \$ 75.00 per unit Net Freight Charge
Shades 125 1/8" or greater in length shipped via Common Carrier: \$ 150.00 per shipment

Mariak

Many Window Solutions From One Source

575 West Manville Street, Rancho Dominguez, CA 90220
 Customer Service Fax: (800) 459-6999 / International Fax: (310) 763-1749
 PH: (800) 562-7425 / (310) 661-4400

Purchase Order Woven Wood Shades

Account #: _____ Company Name: _____ Contact: _____ Purchase Order #: _____
 Ship To Address: _____ Phone: _____ Sidemark: _____
 City: _____ State: _____ Zip: _____ Fax: _____ Date Required: _____

Line	Sidemark	Qty	Mount ¹	Width	Length	Shade Type ²	Pattern ³	Color ⁴	Lift Type ⁵	Lift Side ⁶	Liner ⁷	Edge Binding ⁸	Hold Downs	Wood Bottom Bar ⁹	Spacer Block
1															
2															
3															
4															
5															
6															
7															
8															
9															
10															

Purchase Order Footnotes:

1. Mount: (IM) - Inside Mount (OM) - Outside Mount	3. Pattern: Specify the fabric pattern name.	7. Liner: (None) - Liner Not Required (LF-N) - Light Filtering Natural (LF-B) - Light Filtering Beige (LF-C) - Light Filtering Chocolate (BO-W) - Chocolate Soft White (BO-B) - Blackout Beige (BO-C) - Blackout Chocolate
2. Shade Type: (STND) - Standard Style Shade (WTF) - Waterfall Style Shade (TWN - STND) - Twin Fold with Standard Style Front Shade (TWN - WTF) - Twin Fold with Waterfall Style Front Shade (TDBU) - Top-Down / Bottom-Up Shade (ARCH) - Standard Style Shade with Arch Top Valance (ANGL) - Angled Top Style Shade (2ON1) - Two on One Headrail	4. Color: Specify the color # and name. 5. Lift Type: (PC) - Standard Pull Cord (Cord Lock Mechanism) (CCL) - Continuous Cord Loop (Clutch Mechanism) (MTR-BAT) - Motorized (Powered by Somfy Battery LT30 RTS) (MTR-DC-RTS) - Motorized (Powered by Low Voltage Somfy Sonese 30 RTS) (MTR-AC-RTS) - Motorized (Powered by High Voltage Somfy Sonese 50 RTS) (MTR-AC-HW) - Motorized (Powered by High Voltage standard 4-wire motor)	8. Edge Binding: If desired, specify edge binding color.
	6. Lift Cord Control: (R) - Right Side Lift Cord (L) - Left Side Lift Cord	9. Wood Bar: If desired, specify the wood bottom bar color.

Note: For Twin Style Shades, please note if you want both Pull Cord for the Shade and Liner, Cord Loop for the Shade and Pull Cord for the Liner, or Cord Loop for both the Shade and the Liner.



Many Window Solutions From One Source

575 West Manville Street, Rancho Dominguez, CA 90220
 Customer Service Fax: (800) 459-6999 / International Fax: (310) 763-1749
 PH: (800) 562-7425 / (310) 661-4400

Purchase Order
Woven Wood Folding Door Shades

Account #: _____ Company Name: _____ Contact: _____ Purchase Order #: _____

Ship To Address: _____ Phone: _____ Sidemark: _____

City: _____ State: _____ Zip: _____ Fax: _____ Date Required: _____

Line	Sidemark	Qty	Mount ¹	Width	Length	Shade Type	Pattern ²	Color ³	Stack Type ⁵	Fullness ⁶	Liner ⁷	Valance ⁸
1						Folding Door						
2						Folding Door						
3						Folding Door						
4						Folding Door						
5						Folding Door						
6						Folding Door						
7						Folding Door						
8						Folding Door						
9						Folding Door						
10						Folding Door						

Purchase Order Footnotes:

1. Mount:	(IM) - Inside Mount (OM) - Outside Mount
3. Pattern:	Specify the fabric pattern name.
4. Color:	Specify the color # and name.
5. Stack:	(L) - One Way Stack Left (R) - One Way Stack Right (S) - Split Stack
6. Fullness:	(5%) - Standard Fullness (20%) - Upgrade Fullness
7. Liner:	(None) - Liner Not Required (LF-N) - Light Filtering Natural (LF-B) - Light Filtering Beige (LF-C) - Light Filtering Chocolate (BO-W) - Blackout White (BO-B) - Blackout Beige (BO-C) - Blackout Chocolate
8. Valance:	Specify if valance is desired. Valances are not included in the standard price grids, but are available for a surcharge.

Additional Notes:

- A deduction of 1/4" will be made to the head rail length of all Inside Mount shades.
- For Inside Mount, a deduction of 3/4" will be made to the length of all shades.
- If a valance is ordered, a deduction of 1 1/2" will be made to the length to allow for the valance board.
- No deduction will be made to the length of Outside Mount shades.
- One Way Draw shades stack to the Left or Right when open. Split Draw shades open in the middle and have magnets in the center bars for complete closure.
- Valance will include 5 1/2 inch returns.



575 West Manville Street, Rancho Dominguez, CA 90220
 Customer Service Fax: (800) 459-6999 / International Fax: (310) 763-1749
 PH: (800) 562-7425 / (310) 661-4400

Purchase Order Woven Wood Ring Drapery Panels

Account #: _____ Company Name: _____ Contact: _____ Purchase Order #: _____
 Ship To Address: _____ Phone: _____ Sidemark: _____
 City: _____ State: _____ Zip: _____ Fax: _____ Date Required: _____

Line	Sidemark	Qty of Panels	Individual Panel Width ¹	Net Panel Length ²	Shade Type	Pattern ³	Color ⁴	Stack Type ⁵	Liner ⁶	Edge Binding ⁷
1					Ring Drapery					
2					Ring Drapery					
3					Ring Drapery					
4					Ring Drapery					
5					Ring Drapery					
6					Ring Drapery					
7					Ring Drapery					
8					Ring Drapery					
9					Ring Drapery					
10					Ring Drapery					

Purchase Order Footnotes:

1. Panel Width:	Ring Draperies are sold as individual panels. No deductions will be made to panel width measurements.
2. Panel Length:	No deductions will be made to the length of ring drapery panels. A 3/4" clearance between the floor and the bottom of the drapery panel is suggested.
3. Pattern:	Specify the fabric pattern name.
4. Color:	Specify the color # and name.
5. Stack:	(L) - One Way Stack Left (One way stack drapery panels are only available up to 48" in width). (R) - One Way Stack Right (One way stack drapery panels are only available up to 48" in width). (S) - Split Stack
7. Liner:	(None) - Liner Not Required (LF-N) - Light Filtering Natural (LF-B) - Light Filtering Beige (LF-C) - Light Filtering Chocolate (BO-W) - Blackout Soft White (BO-B) - Blackout Beige (BO-C) - Blackout Chocolate
8. Edge Binding:	All Ring Drapery Panels require and include Edge Binding on all four sides of the panel. Specify the color desired.

Mariak

Many Window Solutions From One Source

BLANK PAGE

575 West Manville Street
Rancho Dominguez, CA 90220
(800) 562-7425
www.mariak.com